

# A REVIEW OF THE BENEFICIATION AND EXTRACTIVE METALLURGY OF THE PLATINUM GROUP ELEMENTS, HIGHLIGHTING RECENT PROCESS INNOVATIONS

STEVE COLE, C. JOE FERRON — SGS

## INTRODUCTION

The six platinum-group elements (PGE): ruthenium, rhodium, palladium, osmium, iridium and platinum, together with gold and silver, are considered to be “precious” metals. The recent spike in platinum and palladium prices coupled with the projected increase in demand for the metals has fuelled a spate of exploration and new projects in the PGE sector. Historically, primary producers of PGE metals have controlled the flow of information relating to the mining and processing of these ores into the public domain. Very little published information relating to individual operations and processes is available in comparison to the available literature relating to other metals.

The purpose of this paper is to provide a general overview of the issues relating to the processing of PGE ores. Each topic discussed could easily be the topic of a paper or book and so, in many cases, only the surface of the topic will be scratched. An attempt has therefore been made to provide as many references as possible. The intent of the authors is to review and compare metallurgical processes from a technical point of view, without reference to the size of the operation. If one wants to keep things in perspective, one should not forget that in 2000, two countries, namely South Africa and Russia, produced more than 90% of the world's Pt, Pd and Rh supply (Appendix 1).

The paper is comprised of three main sections. The first section briefly describes the various PGE ore types and the mineralogical factors that affect the recovery of the PGE's.

The second section deals with the beneficiation of the PGE ores, describing the present status and discussing the new trends.

Finally, the third section covers the extractive metallurgy of the PGE's (smelting and base metal refinery), again starting with reviewing the existing operations and ending with a presentation of some of the new trends and technologies in that area, and finally the PGE refining section, the

authors have tried to briefly describe commercial operations, as well as recent developments. In attempting to summarize a large body of work, much detail has been sacrificed. It is hoped that the information provided will be sufficient to highlight some important issues relating to the recovery of PGE and to point the reader in the direction of more detailed information, should this be required.

## TERMINOLOGY

The terms PGE (Platinum Group Elements) and PGM (Platinum Group Minerals) are often used interchangeably, and incorrectly, in the processing and metallurgical literature. The terminology is confused further by PGM being referred to as platinum group metals (which is strictly correct) but often leads to the abbreviation of PGM, which refers to the mineral and not the metal. The abbreviation, PM, should be avoided as this includes silver, and silver is not often associated with platinum group metals (Cabri, 1981a).

## HISTORY

Naturally occurring platinum and platinum-rich alloys have been known to mankind for hundreds of years. The Spaniards named the native metal “platina” or little silver, when they first encountered it in Colombia. They

regarded platinum as an unwanted impurity in the silver that they were mining (Wagner, 1929).

In the early 1900's, the only significant uses for PGE's were for laboratory ware, as catalysts in the manufacturing process of sulphuric and nitric acids and in jewellery. The supply of this metal was primarily from placer deposits in the Russian Urals, southwestern Alaska and gold placers in California and from co-production of PGE metal from Sudbury basin ores.

In 1920, Hans Merensky discovered the PGE reef bearing his name in the Bushveld Igneous Complex in South Africa. For many years, this reef has been the primary source for the majority of the PGE used worldwide.

In the 1960's, improvements in analytical techniques for determining trace amounts of PGE were developed. This led to a better understanding of the geochemistry of PGE occurrences and hence an interest in looking for PGE deposits in areas previously unexplored for PGE, such as the Stillwater area.

During the 1970's the United States government introduced legislation mandating a reduction in the level of pollutants emitted from automobile exhausts. Catalytic converters containing platinum, palladium and rhodium (in varied combinations) were accepted by the automobile industry as a technology that would enable them to comply with the new legislation. During the 1980's and 1990's, the demand for platinum was growing every year in response to new requirements for catalysts in general (not only for the automobile industry), demands from the electronic industry, and an increase in the amount of platinum used in the jewellery industry. Since the mid-1970's, the UG2 reef, in the Bushveld Igneous Complex, has been increasingly exploited for its PGE content. Until recently, the mining companies exploiting this reef were the same mining companies exploiting the Merensky reef, some 15 to 330 meters above the UG2 reef.

In 1986, the Stillwater project heralded the first major primary PGE project in North America. The Lac des Iles mine (owned by North American Palladium Ltd.) followed the Stillwater success story in 1993. There are currently a number of exploration projects targeting primary and secondary PGE deposits in North America (see, for example, in this volume: Farrow and Lightfoot; Barrie et al.; Peek et al.)

Throughout the history of development of primary PGE deposits, Canada has supplied PGE metals as a by-product of nickel and copper mining, primarily from the Sudbury and Thompson regions. Inco started production of PGE in 1908 when it opened a refinery in the U.K. to refine ores from the Sudbury basin (Johnson Matthey, 2001).

### SECTION I: CLASSIFICATION OF PGE ORES AND MINERALOGICAL FACTORS RELATING TO RECOVERY

There are various methods (mineralogical, sulphur content, chromite content, grade of PGE, etc.) used to classify ore types, each with merits and disadvantages. The

classification presented in this paper uses a combination of PGE content and mode of geological occurrence to group ore types. Figure 1 depicts the "family tree" of PGE ores as defined by this classification. It should be noted that this classification system has been largely adopted from the classification presented in CIM Special Volume 23 (Cabri, 1981a). The information presented in this section was largely assembled from Chapters 10 (Naldrett, 1981) and 11 (Cabri, 1981b) of that volume.

In this classification PGE ores are divided into three primary classes:

- PGE dominant - Those ores exploited primarily for their PGE content with other metals such as Cu, Ni and Co being produced as co-products. The economic values of the co-products are, in general, minor in comparison to the PGE values.
- Ni-Cu dominant ores - Those ores exploited primarily for the Ni and Cu content. The PGE are produced as a co-product. The economic importance of the PGE in these ores can vary

from being fairly minor to being the "deciding factor" on project economics.

- Miscellaneous ores - These are ores in which PGE values have been noted but not recovered due to low concentrations or recovered as a by-product with little or no economic advantage for the primary producer. Typically, little is known about the distribution and recovery of the PGE in these ores. An example of this type of ore is that PGE is recovered from copper refining in the United States. However, PGE content and recovery is rarely determined for any of the concentrates feeding the smelting process. PGE values in the primary ore contribute no financial value.

A key point to note is that regardless of the mode of formation, a detailed study of ore mineralogy is essential when considering the metallurgical response of a PGE ore since mineralogical variations within a particular mineralized horizon (or reef) can be as significant as variation between ore types. Cases in point are

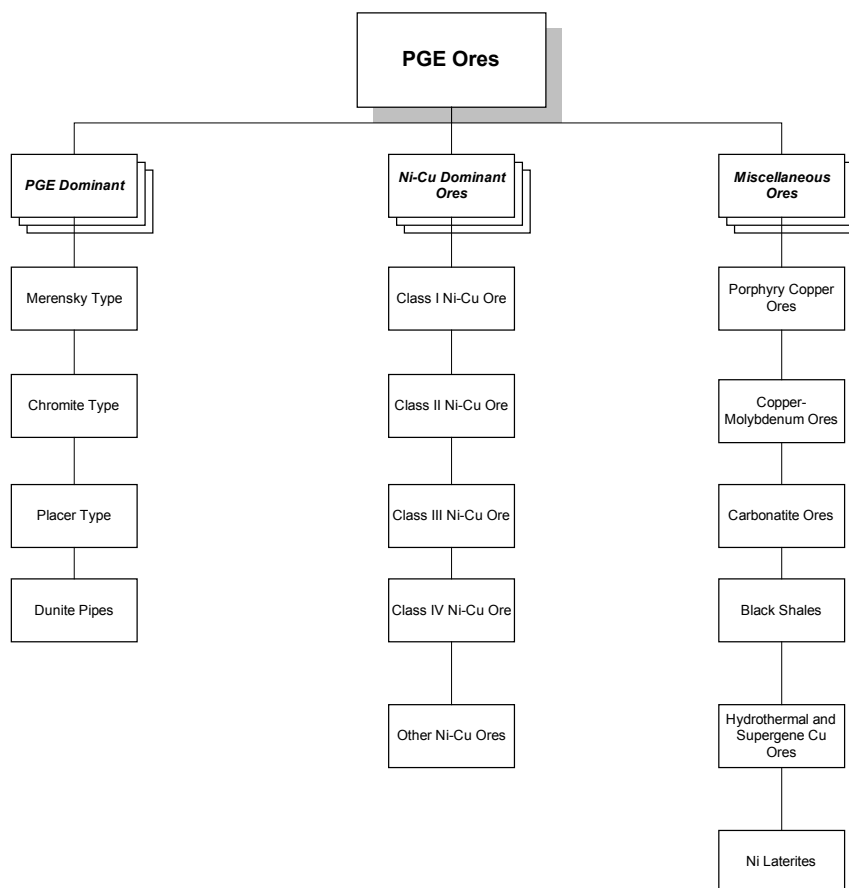

Figure 1. Classification of PGE Ores

the variations noted in the Merensky reef on both a regional and mine site scale. (Cawthorn et al., this volume).

## PGE DOMINANT ORES

### Merensky Type

These deposits occur in very large bodies of basaltic magma, which intruded into stable continental rocks. In general, the Merensky type deposits are layered with disseminated sulphides. The total sulphide content is fairly low; in some cases, the PGE are associated with chromite as well as sulphides. Some examples of this type of deposit are the Merensky Reef in South Africa (Cawthorn et al., this volume) and the Great Dyke in Zimbabwe (Oberthur, this volume). The Stillwater complex is thought to be similar in nature to the Merensky type deposit (Zientec et al., this volume). The Platreef horizon located in the Potgietersrus area of the Bushveld complex is substantially different to the Merensky reef, but is considered to be the local equivalent of the Merensky reef (Hochreiter, et al., 1985). Typical grades of PGE for this type of deposit range from 3 to 20 g/t PGE.

### The Merensky Reef

In this case the term "reef" refers to a pegmatoid zone that is, in general, bounded by two thin (2-3 mm) chromite layers. Mill head grades typically vary from about 4 to 8 g/t PGE + Au. It should be noted that as the mineralogy of the Merensky reef may vary in terms of PGE, Base Metal Sulphides (BMS) and gangue mineral characteristics, the following comments are generalisations. The PGE occur as discrete PGM (primarily braggite, cooperite, laurite, sperrylite, moncheite and Pt-Fe alloys intergrown with base metal sulphides – see appendix 2 for formulae of PGM) and in solid solution with the Cu, Ni and Fe sulphides. The principal opaque sulphide minerals are pyrrhotite, pentlandite and chalcocopyrite, listed in order of decreasing abundance. Minor sulphides include cubanite, mackinawite and pyrite (Cabri, 1981b; Cawthorn et al., this volume). Typically, the PGE will occur as fine inclusions within the BMS or as intergrowths between the BMS and gangue contact surfaces, which aids liberation during the grinding process. In general, the liberation size is fairly coarse

with most operations choosing a grind size ( $P_{80}$ ) between 75 and 150  $\mu\text{m}$ . The presence of talc in some areas can cause significant process difficulties.

### The Stillwater Complex

- The production from the Stillwater complex originates from the J-M (Johns-Manville) reef. Unlike the Merensky reef where Pt is the primary PGE, Pd is the most significant PGE present in the Stillwater complex. The principal opaque minerals are pentlandite, pyrrhotite and chalcocopyrite. The principal PGE are braggite, vysotskite, moncheite and Pt-Fe alloys (note the similarities with the Merensky PGE suite). It should be noted that there is a larger suite of opaque minerals and PGE minerals associated with the J-M reef relative to Merensky reef. The PGE vary considerably in size from 1 to 200  $\mu\text{m}$  in size. Braggite and vysotskite are coarser-grained while the Pt-Fe alloys tend to be finer grained. The amount of PGE in solid solution with the base metal sulphides is variable with the amount of Pd present in pentlandite, varying from 0.04 to 1.5%. An average head grade for the mill would run at about 24 g/t PGE (Turk, 2001). The talc in the ore is yet another similarity between the J-M and Merensky reefs.

### The Lac des Iles Complex

The primary PGE in the Lac des Iles complex is Pd. Major opaque minerals include pentlandite, pyrite, chalcocopyrite and pyrrhotite. The most abundant PGE is vysotskite (reported to have close associations with pentlandite). Other PGM present include the braggite series of minerals, kotulskite, as well as antimonides and sulphantimonides (Watkinson et al., this volume). As with the Merensky reef, there is a fair amount of variability in the relative abundance of the PGE. Similar to the Merensky and JM reef, the PGE also occur in solid solution with the BMS, with the pentlandite containing between 0.02 and 0.65% Pd. The presence of talc in the ore is consistent with the Merensky type ore. The average mill head grade for 2000 was 4.5 g/t Pd (North American Palladium Ltd., 2001).

### Great Dyke

The most recent publication on the Great PGE deposits is that of Oberthur (this volume). The BHP-owned mine, Hartley Platinum, was exploiting this ore body and failed because of mining problems relating to grade dilution (no marker for the reef such as the thin chromite layers associated with the Merensky reef). The average head grades for this reef are approximately 4 g/t PGE with about 55% of the PGE content present as Pt. The Mimosa mine has been exploiting this ore body successfully for a number of years and has just expanded its operations (Johnson Matthey, 2001).

### Chromite Type

Two types of chromite deposits are economically or potentially economically significant.

Stratiform chromite deposits occur in the Bushveld complex (UG2 reef, the UG, LG & MG series reefs), the Great Dyke, the Stillwater Complex (lower chromitites), and the Muskox intrusion (Northwest Territories).

### The UG2 Chromite

The reef consists of 60-90% chromite, 5-25% orthopyroxene and 5-15% plagioclase with trace amounts of base metal sulphides. The primary sulphides are pentlandite, pyrrhotite, chalcocopyrite and pyrite. The sulphide grains occur typically in the size range 1 to 30  $\mu\text{m}$  and occur mostly in the chromite grain boundaries. This phenomenon assists in liberation of the BMS, as the ore will only need milling down to the natural chromite grain size (typically about 100  $\mu\text{m}$ ) in order to expose the BMS surfaces. The BMS can then be liberated by detachment. The PGM are typically associated with the BMS and will have a size ranging from 1 to 2  $\mu\text{m}$ , and rarely exceeding 20  $\mu\text{m}$ . The principal PGM in the UG2 reef include: malanite, laurite, cooperite, braggite, Pt-Fe alloy, sperrylite and vysotskite. The PGM may also occur as single grains along chromite grain boundaries or as inclusions within chromite or other silicate gangue minerals (Cabri, 1981b; Merkle and McKenzic, this volume).

### The Lower Chromitites, Stillwater Complex

Although mineralogical studies have shown the presence of PGM and BMS within these rocks it is unlikely that they will ever be economically exploited. The and encased in chromite (Cabri, 1981b; Zientek, this volume) and olivine and thus not amenable to recovery by flotation unless very fine grinding is employed to liberate these minerals. It is likely that the grinding costs associated with the process will make the economics of the project unfavourable.

Podiform chromite deposits are mined primarily for their metallurgical grade chromium content. These chromitites may be enriched in Os-Ir-Ru alloys. In the future, recovery of PGE as a by-product may be considered. Literature suggests that the Chinese may have already investigated this possibility (Cabri, and Laflamme, 1981; Zhou et al., this volume). As such the Podiform chromite deposits should be strictly classed with the "other" miscellaneous deposits.

### Placer Type

These deposits include alluvial, eluvial and Alaskan-derived type deposits.

The PGM for all Alaskan-type bedrock deposits and their derived placers are similar. The most common PGM are Pt-Fe alloys and Ir-Pt alloys (Ir, Pt) is the next most common minerals. Less common PGM such as osmium (Os,Ir,) and iridium (Ir,Os) are also present, as well as a considerable number of rare PGM (Johan, this volume; Weiser, this volume).

The alluvial and eluvial deposits are typically derived from weathered ultramafic rocks. The PGM typically occur as Pt-rich alloys in the form of loose grains or nuggets. The high specific gravity and resistance to weathering result in the concentration of Pt-rich PGM grains in placers along with other minerals with high specific gravity. Placer mining is believed to have begun in Colombia in the 1700's. Production from placer deposits in Russia began in the 1800's. In some alluvial deposits, the PGM grains penetrate the underlying bedrock, enriching the surface layers.

In the majority of placer deposits, the grain size decreases with increasing distance from the primary source. This is significant when using placer deposits for exploration purposes and should also be taken into account when selecting processing equipment for the recovery of various size ranges of PGM. In black placer sands, a portion of the Pt values may report to a magnetic concentrate, as some Pt-Fe alloys are ferromagnetic. The presence of other heavy minerals in large quantities together with PGM may complicate recovery as these minerals will be recovered simultaneously with the PGM, thus, diluting the final concentrate.

### Dunite Pipes

Dunite pipes occur in the eastern and western sections of the Bushveld complex. These pipes have had reported grades of up to 2000 g/t PGE in some sections. (Wagner, 1929). (Cut-off grades of 3 g/t PGE have been reported). The mineralogy of the pipes differs greatly from the Merensky and UG2 reefs in that the sulphides of the PGE are rare. Fifty percent of the PGM are present as Pt-Fe alloys; a further 30% of the PGM are present as sperrylite and geversite. (Cabri, 1981b). These pipes were exploited in the early 1900's. The PGM were recovered using gravity recovery methods, with recoveries between 82% and 86% (Wagner, 1929).

### Ni-Cu DOMINANT ORES

As mentioned above these are ores in which the primary financial value is due to the Ni and Cu values. The PGE are recovered as co-products and play a "lesser" role in project economics.

The classification and mineralogy for these ores will not be discussed in detail, as the mineralogy and metallurgy of these ores are well known and well understood, and not subject to the "culture" of secrecy that has built up in the primary PGE production sector.

The following four classes of Ni-Cu ores account for 95% of known Ni-Cu ores.

- Class I: Noritic rocks associated with an astrobleme (meteoric impact). The only known example of this ore type is the Sudbury ore.

- Class II: Intrusive equivalents of flood basalt associated with intercontinental rifting. The most significant example of this ore type is the Noril'sk deposit in Russia. The Duluth complex in Minnesota is another example of this class of ore.
- Class III: Magmatic activity accompanying the early stages of formation of Precambrian greenstone belts. This class can be subdivided into two further classes. Examples of Class III deposits include the Kola Peninsula, Lyn Lake, and Thompson and the Northern tip of the Ungava Peninsula in Canada.
- Class IV: Tholeiitic intrusions, generally synchronous with orogenesis in Phanerozoic orogenic belts.

The PGE in the ore types mentioned above occur as discrete PGM and in solid solution with BMS, and to a lesser extent with gangue minerals. PGE recovery is not the prime driving force behind the flowsheet development and optimization. However, in recent years, a concerted effort has been made to study the mode of loss for the PGE and to attempt to recover more PGM into the Cu and Ni concentrates.

### MISCELLANEOUS ORES

These are ores in which the PGE is present either in solid solution with other minerals or as discrete PGM. The PGE are considered "accessory" metals and the deposits are not mined for the sake of the PGE and in some cases the PGE are not recovered as a co-product. The following is a list of ores and deposits where PGE are present as an accessory metal:

- Porphyry Copper Ores: PGE are recovered from Cu refineries in the United States and Canada as a by-product.
- Copper-Molybdenum Deposits: Deposits in Armenia have measured up to 0.08 g/t Pd and 0.018 g/t Pt.
- Carbonatite: The Palabora carbonatite complex in South Africa produces Cu from a low-grade chalcopyrite-valleriite ore. The cathode slimes contained about 16200 g/t PGE in 1974 (Note: the corrected figure is given in Cabri, 1989, p 246).
- Black Shales: The base metal-bearing

black shales from the Zechstein basin (Poland) contain PGE values ranging from 20 to 400 g/t. Some PGM have been identified but it is believed that the platinum forms organic compounds with kerogen.

- Hydrothermal and Supergene Copper Ores: Pt and Pd-rich samples have been identified from the New Rambler mine in Wyoming.
- Nickel-bearing Laterite Deposits: Ni laterites are formed by the chemical weathering of ultramafic and mafic rocks. The PGE hosted in the original rock are concentrated in the Ni laterite. Concentration ratios are reported to range from 0.7 to 7 times the values in the original host rock. An example of this type of deposit would be the Black Range Syerston Project in Central New South Wales, Australia. (Motteram, 2000).

It is important to note that the majority of current primary PGE production is derived from sulphide ores.

## SECTION II: BENEFICIATION OF PGE ORES

### OVERVIEW

The typical commercial method used for the recovery of PGE from primary ores (other than placer deposits) is flotation. The flotation stage in recovery of PGE is responsible for the biggest single loss of PGE along the process route. Thus, it is logical that the concentrators should be the focus of extensive research and development to continually improve on the process.

Some differences between typical base metal flotation circuits and flotation circuits designed to treat PGE ores are listed below:

- Pyrrhotite recovery vs. pyrrhotite rejection: Various electron microprobe studies have shown that pyrrhotite and other BMS contains varying amounts of PGE in solid solution (Cabri, 1992; Distler et al., 1999). In addition to the PGE present in solid solution, there can be discreet PGM "locked" within pyrrhotite. This association of PGE and PGM with pyrrhotite highlight the importance of recovering pyrrhotite in a PGE operation. Typically, in non-PGE

recovery circuits, the pyrrhotite is actively rejected or efforts are made to minimise its recovery.

- The risk of over-grinding: The wide range of mineral densities present within typical primary PGE ores (talc ~ 2.7, Fe-Pt alloys ~ 17.0) presents challenges within with grinding and classification circuits akin to those experienced by gold producers with gravity-recoverable gold in the circuit. As cyclones are often used in the classification process, minerals with a high density tend to be returned to the milling circuit and are thus prone to over-grinding that can lead to losses in PGE recovery. The various PGE producers have addressed the problem of over-grinding in many different ways. Solutions to the problem have included the use of screens in the classifying process instead of cyclones, the inclusion of flash flotation (or unit flotation on mill discharge) in the grinding circuit to recover liberated or near liberated minerals from the cyclone underflows and the inclusion of gravity recovery in the milling circuit. Some producers have gone to the extreme of using Mill Float, Mill, Float circuits (or MF2) described in more detail below, to prevent over-grinding of ores. Over-grinding of the ore can also increase the risk of activating or sliming certain gangue minerals (such as talc and chromite) that cause complications in the down stream smelting of the concentrates. Some important Pt carriers, such as sperrylite, tend to losses during over-grinding because of the mineral's brittleness and its different flotation response (Cabri, 1988).
- The recovery vs. grade issue: in typical base metal flotation circuits, a certain minimum valuable metal grade is targeted for the concentrate. In PGE flotation circuits, the circuits are run to maximise PGE recovery with little or no regard for parameters such as combined Cu/Ni grade or total S grade. (Some PGE concentrates have combined Cu/Ni grades of less than 4%.) Some PGE producers buy base metal concentrates to blend with their PGE concentrates to render them smeltable. Factors that can control concentrate quality (and hence recovery of PGE) include PGE grade

(typically greater than 100 g/t PGE total), MgO content (typically 15-20% max) and Cr<sub>2</sub>O<sub>3</sub> content (typically 0.4 to 2.8 max).

- Low concentrations of valuable minerals lead to froth stability and mass pull problems (entrainment etc.)

### TYPICAL FLOTATION FLOWSHEETS

This section presents a number of flowsheets from various operations. The flowsheets have all been published previously. References have been provided with each flowsheet to enable the reader to obtain more detail on each, as the information that can be conveyed here is limited due to the scope and length of this paper.

It should be noted that the ore mineralogy will dictate the process route chosen. Though the flowsheets presented have many similarities, there are many subtle differences in each flowsheet that are the result of subtle and obvious differences in ore mineralogy.

It is stressed that the flowsheets presented are intended to show features that are characteristic of different regions on ore types. No "weighting" has been given to the number of ounces of PGE each type of flowsheet produces.

#### The "South African MF2" Flowsheet

The MF2 circuit derives its name from the terminology Mill, Float, Mill, Float, i.e. MFMF or MF2. Figure 2 depicts a typical MF2 type flowsheet.

The principal behind the MF2 circuit is two-fold: first, to prevent over-grinding of the sulphides, in particular pentlandite which is prone to "sliming". Secondly, to prevent over grinding of actively floating gangue material such as talc. The MF2 flowsheet consists of a primary milling stage followed by primary flotation. The primary rougher tails are then re-ground and floated in a second stage, i.e. milling a rougher tail prior to scavenging. The primary rougher concentrate and the secondary rougher concentrate (scavenger concentrate) are cleaned in separate cleaning circuits with one to three stages of cleaning in each circuit. The cleaning circuits generally operated as a counter-current cleaning

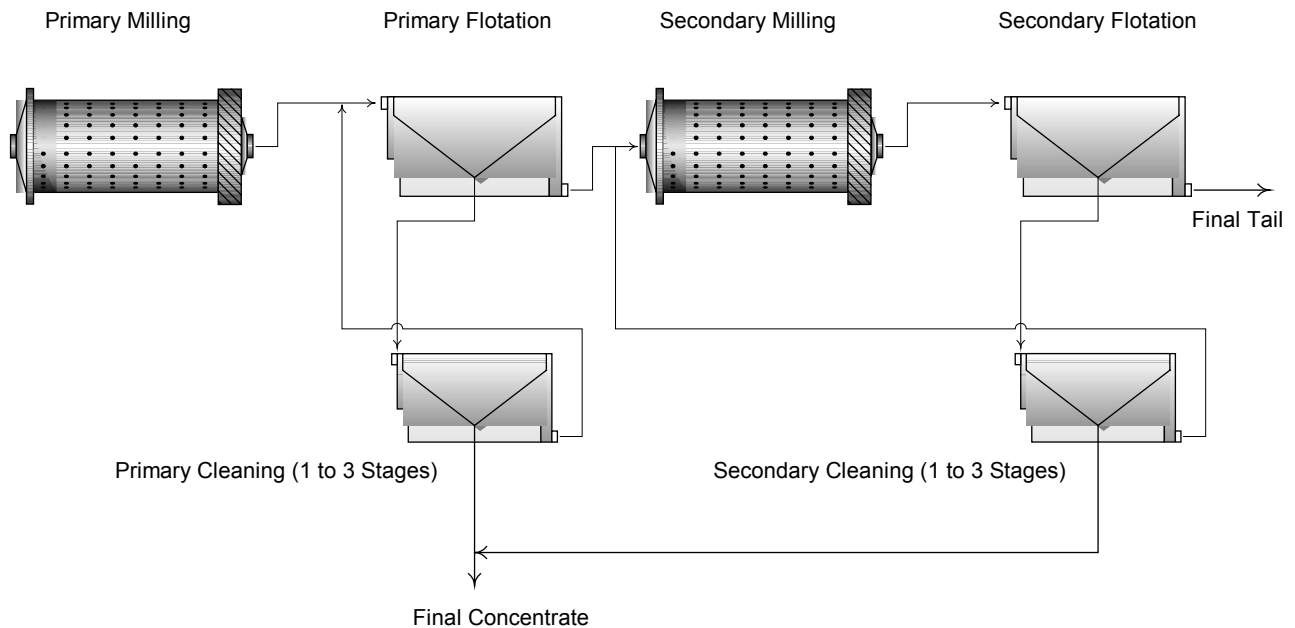

Figure 2. A Typical MF2 Flowsheet

stages. The cleaner tails from the primary cleaner bank recycle to feed the primary rougher, while the cleaner tails from the secondary (scavenger) cleaner bank recycle to feed the secondary mill.

Variations in the flowsheets are numerous and could include:

- The first rougher cells concentrate bypassing the cleaner circuit to report directly to final concentrate
- Gravity concentration of rougher concentrate to recover liberated PGM that will bypass the smelter and report directly to the precious metal refinery
- Flash or unit flotation incorporated into the primary milling circuit

#### The Northam Flowsheet, South Africa

The Northam Merensky concentrator was designed to treat 270 t/h of run-of-mine (ROM) ore. A semi-autogenous grinding (SAG) mill operating in open circuit provides primary grinding. A ball mill operating in closed circuit provides secondary grinding. Flash flotation is carried out on the cyclone underflow. The flash flotation cell recovers over 60% of the PGE in the final concentrate. The cyclone overflow is conditioned prior to flotation. The primary flotation is undertaken in a single rougher/

scavenger flotation bank. The first cell in the rougher bank produces final grade concentrate and this material can be routed directly to the final concentrate. The rougher concentrate is passed directly to the cleaning circuit (no regrinding) that consists of three column cells operating in series. The stage recovery for each column is reported to be as low as 30%. The cleaner (final) concentrate is sent to a concentrate thickener and dispatched to the smelter complex in slurry form. The cleaner tail is recycled back to the head of the rougher circuit. The scavenger concentrate can be routed to the head of the rougher bank or to the cleaner circuit. No grinding is performed on the scavenger concentrate. Figure 3 presents a schematic of the Northam flowsheet. (Snodgrass et al, 1994) presented a detailed description of the Northam mill and process development.

#### The Noril'sk Flowsheet

Details on the concentrators at Noril'sk are difficult to come by in Western literature. The following is a short description of a flowsheet used in one of Noril'sk concentrators to process a disseminated ore from the Noril'sk-1 Deposit.

Primary grinding reduces the ore to 45-50% -200 mesh. A centrifugal type concentrator is used in the milling circuit to recover a PGE concentrate. Up to 40% of the PGE are recovered in the gravity concentration stage. A short rougher flotation stage is utilised to remove liberated sulphides and PGM. This rougher concentrate is routed directly to the final concentrate. The ore is then scavenged, and the scavenger concentrate is cleaned once and reground prior to re-cleaning. The first and second cleaner tails are scavenged in separate circuits. The first cleaner scavenger concentrate is recycled to the rougher tail, prior to scavenging. The second cleaner scavenger concentrate is recycled to feed the first cleaner. The Noril'sk metallurgical group is currently investigating the application of flash flotation (for disseminated ore) and expects that this technology will find a commercial application at Noril'sk (Alekseeva et al). Figure 4 presents a schematic of the Noril'sk flowsheet for disseminated ores. Please note the flowsheet reported by (Kozyrez et al., this volume).

**The Stillwater Flowsheet**

A detailed summary of operations at the Stillwater Nye concentrator is described in a paper presented by (Turk, 2001).

The ROM ore is milled in two stages, utilising a primary SAG mill and secondary ball mill. A flash flotation cell (treating the ball mill cyclone underflow) produces final grade concentrate. The target primary grind size is 145 µm. Primary flotation is undertaken in three stages: rougher flotation, middling flotation and scavenger flotation. There is a tertiary milling stage (using a verti mill) between the rougher and middling flotation circuits. The middling flotation concentrate is recycled back to the head of the rougher circuit while the scavenger flotation concentrate is recycled to feed the middling flotation circuit. Cleaning is achieved in three stages operating in a counter-current configuration. The concentrate from the first stage of the first cleaner bypasses the second stage of cleaning and feeds the third cleaners (two column cells operating in series). The tailings from the first part of the first cleaner are reground prior to further cleaning. The cleaner circuit tails recycle to feed the rougher flotation circuit. Figure 5 presents a schematic of the Stillwater flowsheet.

The plant is reported to have a PGE recovery of 91% and is producing a concentrate containing 2000 g/t PGE. The plant has a capacity of 3000 tonnes ROM per day (Dyas and Marcus, 1998).

**The Lac des Iles Flowsheet**

Lac des Iles has recently commissioned a new concentrating facility as part of its expansion program to increase mill throughput from 2,400 to 15,000 tonnes per day. The information for this section was obtained from a fact sheet issued at an open house to celebrate the expansion (North American Palladium Ltd., 2001).

One SAG mill feeds two ball mills, at a rate of 15,000 tonnes per day. Two banks of roughers and scavengers perform the primary flotation. The rougher concentrate is reground and cleaned in a single stage column. The rougher cleaner tail joins the scavenger concentrate and is reground in three Verti mills. The

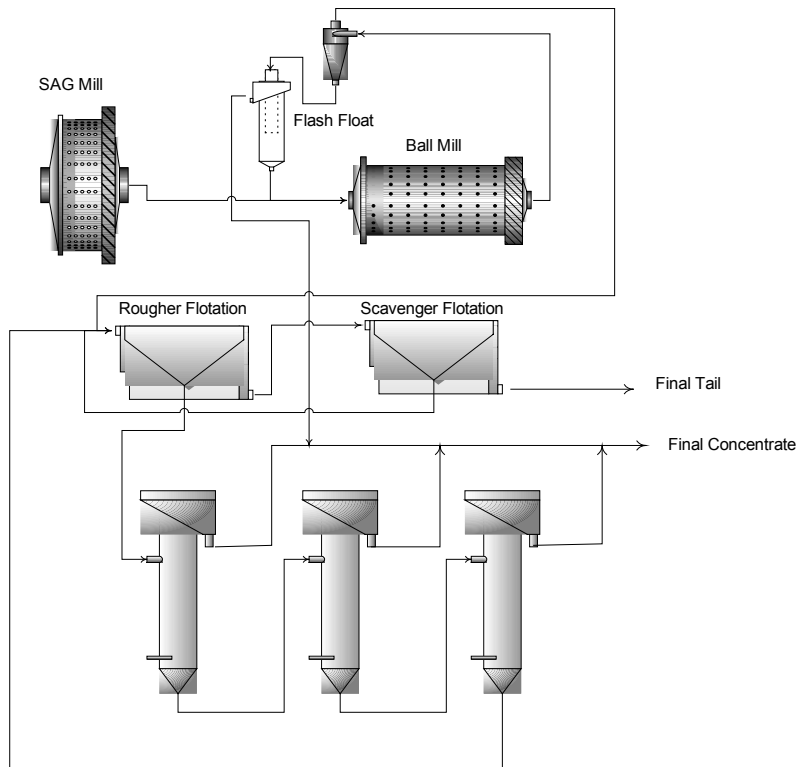

Figure 3. The Noril'sk Flowsheet

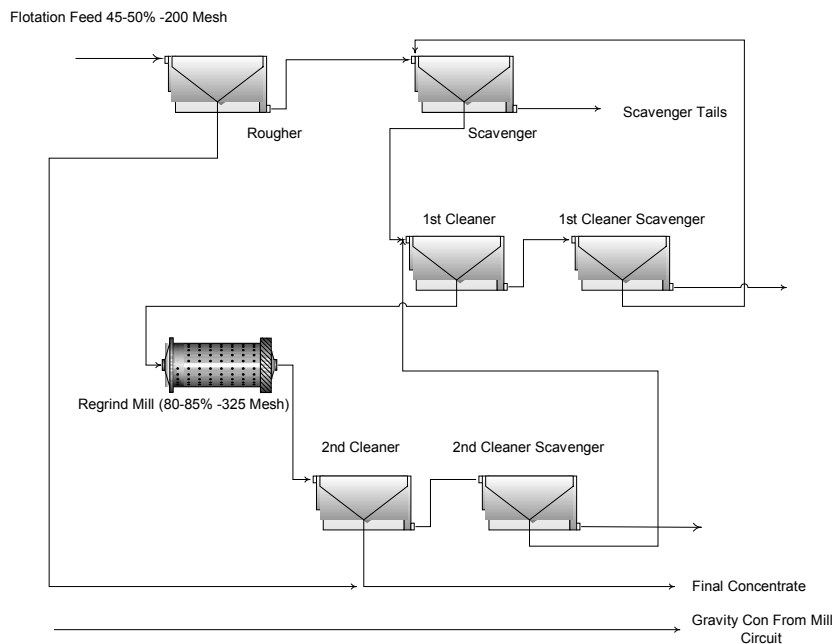

Figure 4. The Stillwater Flowsheet

reground material is then cleaned in three stages, with the cleaners operating in a counter-current configuration. The scavenger cleaner tail reports to the final tail. Figure 6 depicts a schematic of the Lac des Iles flowsheet.

The expected feed grade to the plant is 2 g/t Pd and the targeted recovery is expected to increase from the mid-seventies to the low-eighties.

## REAGENTS FOR THE FLOTATION OF PGE ORES

In general, published literature on reagent suites used in the PGE industry has been sparse. However, there have been a few papers that mention the reagent suites used at the various concentrators.

At Stillwater, the reagent suite consists of four chemicals. The collectors used are potassium amyl xanthate, at a rate of 47 g/t and dithiophosphate (Cytec 3477), at a rate of 35 g/t. No frother is used as the ore is "naturally frothy" and 3477 is a mildly frothing collector. The original design did not use any 3477 but it was found to increase PGE recovery by 2-4% (Hodges, Clifford, 1998).

The collectors are added to the flash flotation cell, the rougher conditioner and the middlings feed (Turk, 2001). Carboxymethyl - cellulose (CMC) is used for talc control and is added at a total rate of 450 g/t (Hodges, Clifford, 1998). The CMC is added to the flash flotation cell, the rougher conditioner, the cleaner conditioner, the second cleaner feed and the middlings feed (Turk, 2001). It should be noted that the reagent dosage rates will in all likelihood change over the years in response to varying ore compositions. Sulphuric acid is used in the rougher conditioner and middlings feed to control the pH to about 7.8. It has been noted that the recovery of PGE drops off dramatically at the natural pH of the milled ore.  $\text{CuSO}_4$  (used as an activator) which was part of the original reagent suite but was removed as it did not contribute any apparent benefits in terms of recovery.

The Lac des Iles reagent suite utilises potassium amyl xanthate and dithiophosphate (3477) as collectors, CMC as a depressant (for talc) and methyl isobutyl carbinol as a frother. The author possesses no published information as to the dosages used. The circuit operates at natural pH (North American Palladium Ltd., 2001). South African producers are loath to publish any specific data on reagent suits due to the historic culture of secrecy in the industry. Typically the collectors used are isobutyl xanthate and dithiophosphate. Xanthates are added at rates varying from 30 g/t to

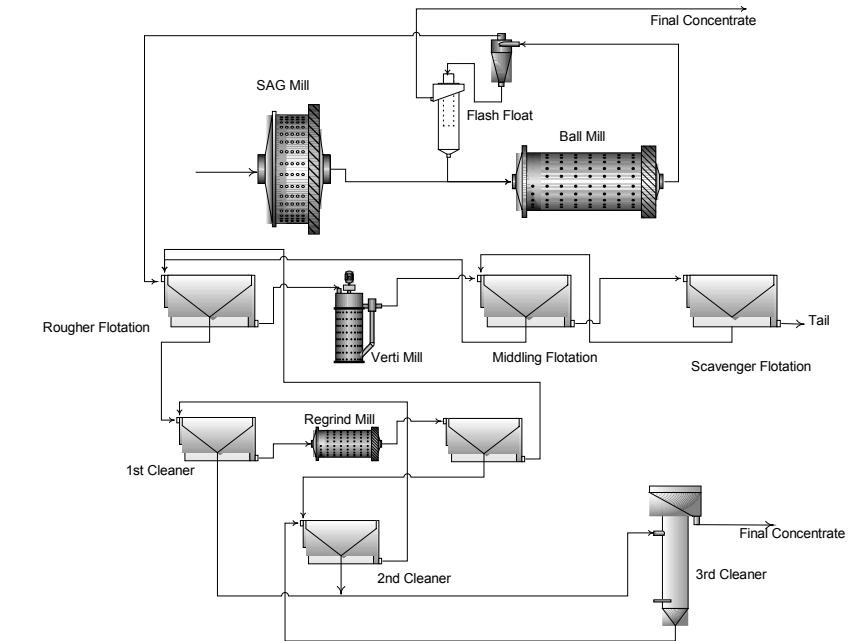

Figure 5. The Lac des Iles Flowsheet

200 g/t. Dithiophosphates are added at rates varying from 10 g/t to 100 g/t. The collectors are generally added to the rougher feed and scavenger feed. CMC is used as a depressant and is generally added to the cleaning circuits. Various frothers are used by the various producers.

The Noril'sk-1 mill (for disseminated ores) is reported to use isobutyl xanthate, sodium aerofloat (no designation given) and organic oil-soluble calcium sulfonate in their reagent scheme for disseminated ores. No information was published on reagent dosage rates or dosage points (Alekseeva et al, 2000). Note that Kozyrev et al. (this volume) report a reagent scheme (used in the Noril'sk-Talakh region) consisting of sodium butyl dithiophosphate; potassium butyl xanthate for collectors, sodium dimethyl dithiocarbonate as a depressant;  $\text{NaHSO}_3$  as a modifier and  $\text{CaO}$  for pH control; pine oil and T-80 are used as frothers.

## NEW TRENDS AND TECHNOLOGIES

### The Use of Centrifugal Gravity Concentrators

Knelson and Falcon type centrifugal-type concentrators are being tested in a number of applications in a number of operations. The Noril'sk mining company reports that up to 60% of the Pt and 13% of the Pd were recovered in the gravity concentrator (see also

Kozyrev et al., this volume). The grade of the concentrate was 400 to 500 g/t PGE. The equipment was tested on the disseminated ore with a feed grade of between 4.5 to 5.9 g/t Pt and Pd (Blagodatina et al, 2000).

### The Use of Dense Media Separation -

Dense media separation is being used to upgrade UG2 ores prior to milling. This enables miners to use wide reef mining techniques, substantially reducing mining costs. The chromite reef is removed from the lower density country rock. The most recent example of this type of installation is the new Kroondal mine. The technology is being considered for the Impala Winaarshoek project, scheduled for construction in the first part of 2002 (Lawrence, 2001).

### The Use of Large "Tank" Type Flotation Cells

More and more producers are using large tank type cells in new installations and plant upgrades. The motivation behind moving to the larger cells is largely driven by lower capital and operating costs associated with using large equipment, rather than many smaller units. Although subjective, it is possible that simplifying the process and reducing the number of streams that an operator will need to monitor can improve the overall metallurgical performance of a flowsheet. The rationale behind



this thinking is that the operators will dedicate more time to each circuit as a whole and thus improve operational response to the ore. Examples of large tank cell installations are the Impala Merensky plant that has 18 x 130 m<sup>3</sup> tank cells in the rougher circuit and the new Lac des Iles concentrator that has 14 x 130 m<sup>3</sup> tank cells in the scavenger circuit.

**Diagnostic Metallurgy and the Role of Process Mineralogy**

Detailed size-by-size analysis encompassing both metal and mineralogical balances of gangue, sulphide and platinum group minerals is helping the industry to build a detailed database of metal loss to tailings. Although these investigations are time consuming and costly, the benefits far outweigh the costs. Technology and methods to improve analysis time are actively being pursued. In South Africa, the platinum industry is known to use SEM-based imaging technology to significantly improve both final recovery and final concentrate grade in their concentrates. This technology is also used in Canada for Ni-Cu ores, for example, at Falconbridge.

**Ultrafine grinding**

A feature commonly found in precious metal flotation cleaner circuits is the presence of high circulating loads. The reasons for running high circulating loads in PGE flotation circuits are varied. In particular they include the presence of complex middling particles and the presence of PGE-containing base metal sulphides such as pyrrhotite that tend to exhibit slower flotation kinetics with extended residence times in a flotation circuit. In the South African platinum industry there has always been a hesitancy to use re-grinding in the cleaner circuits for a number of reasons including the fear of sliming potentially floatable particles (thus reducing probability of recovery) and “activating” gangue minerals such as talc. Recent test work has focused on ultra fine grinding of the cleaner tailings followed by flotation. It has been reported that the newly liberated PGM and base metal sulphides exhibit high flotation recoveries and that the cleaner tails can often be open-circuited. A further advantage of

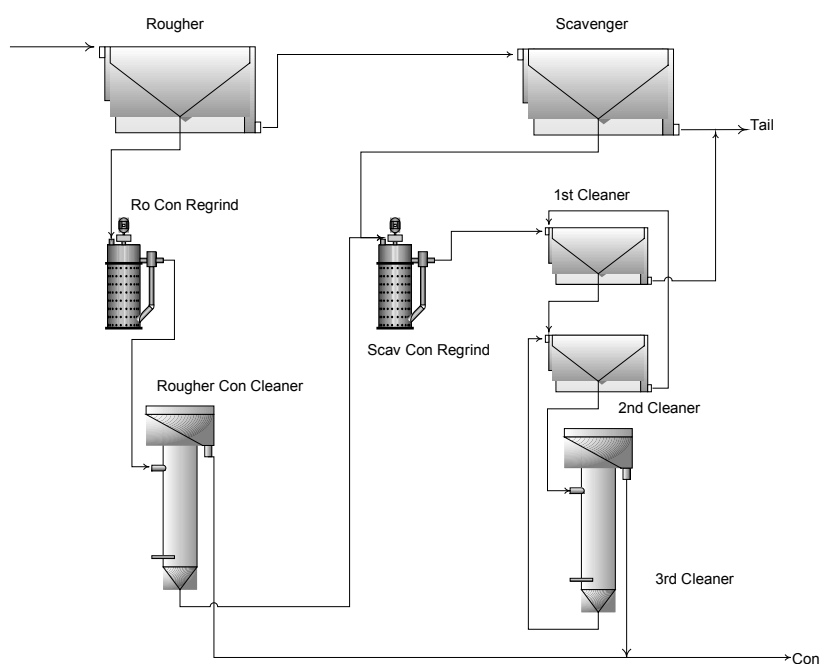

Figure 6. PGE Feed Materials Discussed in this Review

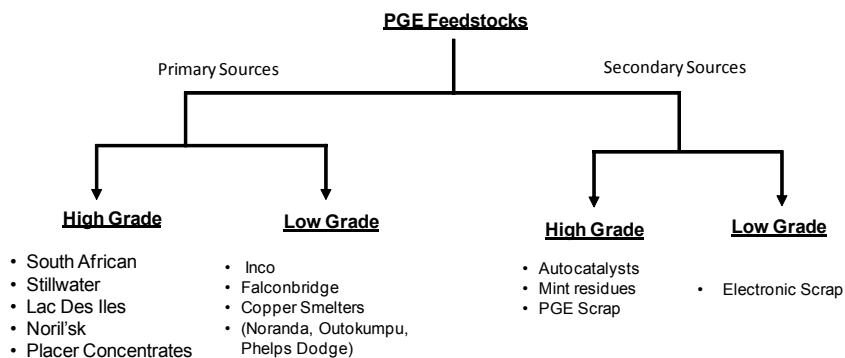

Figure 7. Standard Enrichment Process for High PGE Grade Concentrates

Table 1. Grades and Values of High Grade PGE and Typical Base Metal Concentrates

CONCENTRATE TYPE	GRADE	VALUE * (US\$/TONNE)
Copper	20-30% Cu	370-560
Zinc	50-60% Zn	460-555
Lead	60-70% Pb	290-340
Nickel	5-12% Ni	330-790
PGE	0.02-0.2% PGE	2,330-23,330
Cu: 85 ¢/lb; Zn: 42 ¢/lb; Pb: 22 ¢/lb; Ni: 3 \$/lb; PGE: 350 \$/oz		
* Assumed metal prices:		

open-circuiting is that additional residence time is gained on the rougher bank by not re-circulating the cleaner tail. One South African PGE producer has reported (Steyn et al, 2001; Curry, 2001) obtaining upgrade ratios of more than 60 when grinding cleaner tails from a P<sub>50</sub> of 18.6 µm to a P<sub>50</sub> of 7.1 µm. Recoveries of PGE from the tails doubled. It should be noted that energy requirements for this size reduction are very high at approximately 60 kWh/t (Goodall et al., 2001).

### Circuit Simulation and Optimization

The platinum producers in South Africa have been actively involved with the Amira P9 project to gain a deeper understanding of the fundamentals that govern flotation performance. One part of the flotation research module in which the Julius Kruttschnitt Mineral Research Centre (JKMRC) and the University of Cape Town (UCT) collaborate is the Flotability Characterization Test Rig (FCTR). The FCTR is essentially a portable pilot plant with monitoring equipment that is used to evaluate circuit changes, design concepts and trial equipment. The test rig includes equipment needed to gather data required to model the system being tested. The model is validated against the "pilot plant" data obtained from the FCTR. (JC World, 2001).

### Froth Imaging

A number of groups are working on froth imaging or "machine vision" systems. The objectives are to capture data such as the average grey level and froth structure and to correlate the parameters with the metallurgical performance of the flotation process. The effect of process parameters such as conditioning time, and intensity as well as reagent additions on the froth structure has been studied and correlated to the froth structure and metallurgical performance. (Moolman et al., 1996) (Aldrich et al., 1997).

## SECTION III: THE EXTRACTIVE METALLURGY OF PLATINUM GROUP METALS

### OVERVIEW

The extractive metallurgy of the platinum-group elements is fairly complex and cannot possibly be covered in any detail in this overview. Therefore, most aspects of the PGE extractive metallurgy are covered, without in-depth analysis, but rather by providing a detailed list of references to those interested in further investigating any specific aspect.

Moreover, this review intends to cover not only the processes industrially applied but also other new technologies developed for commercial application.

A general observation to make before discussing the extractive metallurgy of the PGE is the grade of the concentrates produced. Table 1 compares the grades and values of typical concentrates that are processed to generate pure metals.

The values shown in Table 1 have two implications on the extractive metallurgy of the PGE: the PGE concentrates are too low-grade to be refined directly, and will need to undergo an enrichment step prior to refining. On the other hand, their value is so high that the enrichment step has to occur with minimum losses. The enrichment step for primary and secondary sources of PGE concentrates (high and low grades) will be considered first, followed by the refining step before discussing new developments. As shown in Figure 7, both primary and secondary sources will be discussed.

### THE ENRICHMENT OF PGE CONCENTRATES

The PGE concentrates processed to recover their values can be divided into primary (i.e. concentrates) or secondary sources (recycled products like auto catalysts, electronic scrap).

Both primary and secondary sources can be subdivided into high grade and low grade concentrates; the high grade concentrates will be treated primarily for their PGE content, while the PGE in the low grade concentrates are recovered as by-products of other metals, primarily copper and nickel.

#### Primary Sources

Typical PGE concentrates from primary sources are, for example, the South African producers, Lac des Iles, Noril'sk (although primarily a nickel producer, currently has more value from PGE, Likachev, 1999) and Stillwater for the higher grades, or the Sudbury Basin producers, (Falconbridge, Inco) for the lower grades.

#### High Grade Concentrates

Typical concentrate grades will range from 200 g/t PGE to over 2,000g/t. The enrichment step is illustrated in a simplified form in Figure 7. It is usually a two-step process consisting in a pyrometallurgical step followed by a hydrometallurgical step.

### Pyrometallurgical Enrichment

Flotation concentrates generally need to conform to many specifications to render them ideal for smelting. Parameters that tend to be important for concentrates generated from primary PGE producers include:

- Sulphur content (if needed, sulphide rich ores are added to the smelting furnace to collect the PGE)
- MgO content (typically 15-20%). Excess MgO is deleterious;
- Cr<sub>2</sub>O<sub>3</sub> content (typically 0.4 - 2.8%). Excess Cr<sub>2</sub>O<sub>3</sub> is deleterious; and
- Deleterious elements for smelting, e.g. arsenic and bismuth

Limitations of the conventional smelting and converting processes (Jones, 1999) include:

- SO<sub>2</sub> emissions from the converting process are a continuing environmental concern. Intermittent operation of the converters makes handling of the off-gas in a sulphuric acid plant difficult.
- If ores with low sulphide contents are processed, additional base metal concentrates need to be purchased to provide sufficient matte to allow for effective coalescence of the droplets and collection of valuable metals.
- To meet SO<sub>2</sub> dispersion criteria in some parts of the world, smelters have to be shut down during certain climatic periods (low wind velocities, temperature inversions, etc).
- Discontinuous operation of converters is not conducive to stable plant operations.

The flotation concentrate composition must be suitable for smelting. Its rock mineral content should produce a fluid slag at the desired temperature. At the same time, it must contain enough sulphides to form a reasonable quantity of matte. To compensate for minor problems with chemical composition, various fluxes are added. Typically, the main addition is burnt lime or limestone but other materials such as carbonaceous reductants, sulphides, oxides or silicates are used as necessary. Table 2 summarises typical concentrate analysis from South African smelting operations (Jones, 1999). Note the higher Cr<sub>2</sub>O<sub>3</sub> and PGE contents for the

Table 2. Typical South African Concentrate Analyses

	Al <sub>2</sub> O <sub>3</sub> %	CaO %	Cr <sub>2</sub> O <sub>3</sub> %	Cu %	FeO %	MgO %	Ni %	S %	SiO <sub>2</sub> %	PGE g/t
Amplats: Waterval	3.2	4.7	0.80	2.1	20	15	3.6	9	34	143
Amplats: Union	3.8	2.5	2.59	1.1	15	20	2.2	5	38	142
Impala	4.1	2.9	1.1	1.3	18	18	2.1	5.6	42	138
Lonmin: Merensky	1.8	2.8	0.4	2.0	23	18	3.0	9	41	130
Lonmin: UG2 blend	3.6	2.7	2.8	1.2	15	21	2.1	4.1	47	340
Northam	2.6	3.0	0.87	1.3	17	18	2.5	5.4	47	132

UG2 ores. It is also interesting to note the low Cu and Ni values in all of the concentrates.

The concentrates are smelted in electric furnaces. Large units with three to six electrodes in line are used for smelting. Smaller circular furnaces are used to smelt unblended chromite concentrate. Higher temperatures are required to melt chromite concentrates (such as the UG2 concentrates) owing to higher contents of chromium and magnesium oxides. More turbulent smelting conditions are also preferred to avoid build-up of chrome spinel in the furnace hearth. Typically, furnaces are run at about 1350°C, the UG2 furnaces can run at temperatures of up to 1600°C. On melting, the concentrate separates into

two layers. The upper layer is a silicate/oxide iron-rich slag, which is tapped off and then either discarded or returned to the concentrator to recover any remaining PGE. The lower layer is an iron sulphide-rich green matte which is sent for converting. The sulphide minerals form the matte, prills of molten matte coalesces in the slag and then settle out under the influence of gravity (slag S.G. ~ 2.7-3.3, matte S.G ~ 4.8-5.3). The rate of settling is controlled by the viscosity of the slag which in turn can be controlled by the addition of fluxing agents such as limestone. The matte and slag are often tapped at opposite ends of the furnace. The energy requirement for smelting varies from 600-1000 kWh per tonne of concentrate depending on the nature and grade of the material being

treated. The power flux in the furnaces varies between 90 and 235 kW/m<sup>2</sup>. The higher power fluxes are required for the UG2 ores. The furnaces run with a slag to matte production ratio of between 3.5-9.0. Tables 3 and 4 show typical furnace matte and furnace slag analysis from the various South African producers.

The furnace matte is further processed by converting. i.e. blowing of air into the molten charge, over a period of a few hours, to oxidise and remove the iron and its associated sulphur. The oxidation reactions are sufficiently exothermic to maintain a temperature of about 1250°C. The temperature in the converter is controlled by adding cold feed or revert material to the charge. Fluxing agents (mainly silica sand) are added to form an iron-rich slag that is skimmed off and returned to the furnaces. The converter matte is granulated or slow-cooled. If the matte is slow cooled the PGE concentrate on the grain boundaries and tend to form ferromagnetic species that can be recovered by magnetic separation. These ferromagnetic phases are sent directly to the precious metal refinery (Jones, 1999; Chamber of Mines of South Africa, 2001). The converter slag requires further treatment as the vigorous turbulent conditions in the converter cause entrainment of the matte in the slag and oxidising conditions cause some base metals to dissolve in the slag in oxide form. The converter slag is usually returned to the smelting furnace, however, in some cases it is treated in a separate slag-cleaning furnace. Tables 5 and 6 show typical converter matte and converter slag analysis from the various South African producers.

Table 3. Typical South African Furnace Matte Analysis (Jones, 1999)

	Co %	Cr %	Cu %	Fe %	Ni %	S %	PGE g/t
Amplats: Waterval	0.5	0.5	9	41	17	27	640
Amplats: Union	0.3	1.9	7	37	12	25	830
Impala	0.4		16	34	20	28	1050
Lonmin: Merensky	0.5	0.23	9.7	37	17	28	1000
Lonmin: UG2 blend	0.5	0.29	9.8	35	17	28	2500
Northam	0.4		7.9	41	16	27	724

Table 4. Typical South African Furnace Slag Analysis (Jones, 1999)

	Al <sub>2</sub> O <sub>3</sub> %	CaO %	Cr <sub>2</sub> O <sub>3</sub> %	FeO %	MgO %	S %	SiO <sub>2</sub> %
Amplats: Waterval	3.3	6.4	0.8	31	15	0.50	46
Amplats: Union	3.0	5.8	2.8	20	13	0.33	41
Impala	6	8	1.2	21	18	0.25	47
Lonmin: Merensky	2.0	9.8	1.2	28	19		44
Lonmin: UG2 blend	3.9	13	2.4	9.2	22		47
Northam	1.5	10	0.8	21	20		44

Recent descriptions of PGE smelters have been given (Cramer, 2001; Ndlovu, 2001; Kruger, 2001; Rule, 2001). As an example of state-of-the-art smelter, Anglo Platinum is presently installing a new smelter complex in Pietersburg, South Africa. The new furnace has been designed by Hatch and is a single,

Table 5. Typical South African Converter Matte Analyses (Jones, 1999)

	Co %	Cu %	Fe %	Ni %	S %	PGE g/t
Amplats: Waterval	0.5	26	2.9	47	21	2100
Impala	0.4	31	0.5	47	21	3430
Lonmin	0.6	29	1.4	48	20	6000
Northam	0.5	27	1.0	51	19	2570

Table 6. Typical South African Converter Slag Analysis (Jones, 1999)

	Al <sub>2</sub> O <sub>3</sub> %	CaO %	Co %	Cr <sub>2</sub> O <sub>3</sub> %	Cu %	FeO %	MgO %	Ni %	S %	SiO <sub>2</sub> %
Amplats: Waterval	0.7	0.4	0.45	0.4	1.17	63	1.1	2.25	2.4	27
Impala	1.8	0.3	0.43	1.4	1.06	64	0.71	1.90	1.0	27
Lonmin	0.7	0.5	0.39	1.4	0.94	65	0.78	1.43	1.7	28
Northam	1.3	0.7	0.4	0.36	1.37	64	0.82	2.18		27

six-in-line-electrode, furnace, of 68 MW nominal operating power installed, capable of smelting 600,000 tonnes per annum of concentrate. Latest advances in furnace technology (waffle cooler) and design will allow it to treat concentrates with elevated levels of chromite (UG-2).

Slag will be tapped continuously, granulated and transported to a slag dump. The green matte is tapped, cast, cooled, crushed to minus 2 mm to suit the new converter at Waterval. This new converter (Wanblad, 2001), an Ausmelt reactor, will produce white matte in two stages. The converter slag containing too high PGE values has to be recycled to the process. Before, when treating low chromite concentrates, the slag could be recycled to the furnace; presently, for high chromite concentrates, the slag is treated by milling and flotation, but a slag cleaning furnace (a 30 MVA circular, 3-electrode furnace) is currently under construction and will be operational in the fourth quarter of 2002.

Detailed metallurgical data are rarely available. Table 7 presents industrial results from the Stillwater Mining Co.'s precious metals smelter (Hodges et al., 1991).

Two additional items are to be pointed out. The first point concerns the unique procedure practised at the Rustenburg Waterval Smelter of Anglo Platinum, (Hochreiter et al, 1985; Schouwstra, 2000) where the smelter green matte is

Table 7. Chemical Analyses of Various Streams in the Stillwater Smelter (Hodges et al, 1991)

ELEMENTS	SMELTER			CONVERTER	
	CONC.	GREEN MATTE	SLAG	WHITE MATTE	SLAG
PGE's (Pt + Pd) g/t	2,500	7,300	15	24,000	260
Cu %	3.6	11.8	0.09	30.5	1.8
Ni %	5.2	17.7	0.12	44.0	2.8
Fe %	15.4	42.8	17.4	1.7	48.0
S %	13.7	27.4	0.5	21.8	2.0
SiO <sub>2</sub> %	31.9	-	45.0	-	18.0
MgO %	12.3	-	14.8	-	-
CaO %	3.0	-	4.2	-	-

Table 8. Typical Operating Temperatures for Smelting Low and High Chromite Concentrates

TEMPERATURE (°C)		
	Low Chromite Feed (<0.5% Cr <sub>2</sub> O <sub>3</sub> ) (Stillwater)	High Chromite Feed (2% Cr <sub>2</sub> O <sub>3</sub> ) (Anglo Platinum Pietersburg)
Matte Tapping	1200-1250	1550
Slag Tapping	1400-1450	1650
Power Density (kW/m <sup>2</sup> )	58	250

slow-cooled for a period of 3 days to facilitate the crystallisation of a metallic Ni-Cu-Fe alloy, representing about 15% wt% of the matte and containing about 99% of the PGE. See for example, some PGE (and Au) concentrations determined on individual minerals from a similar assemblage to the phases found in matte (auge et al., 1999). This alloy is recovered by magnetic separation and the magnetic concentrate undergoes hydrometallurgical treatment whereby the base metals are dissolved leaving an enriched PGE concentrate for the precious metals refinery (PMR).

The second point concerns a clear trend for the South African smelters to treat high chromite concentrates, reflecting the increased proportions of UG2 ores processed

in the Bushveld areas. Anglo Platinum projects that the chromite content of their smelter feeds will increase from 1% Cr<sub>2</sub>O<sub>3</sub> now to 3% Cr<sub>2</sub>O<sub>3</sub> by 2020, if the milling operations do not improve their separation process (Rule, 2001). If one recognizes the significant effect of chrome spinel on slag viscosities, it becomes very clear that smelters handling UG2 concentrates have to improve their process. In practice, this translates into operating furnaces at higher temperatures. Table 8 illustrates the increased temperatures needed to efficiently treat high-chromite concentrates. Power intensity of modern furnaces has significantly increased over the last 35 years, which in turn puts much pressure on the type and quality of refractories and on better means of removing heat from the system (waffle cooler) (Wasmund, Francki, 2001).

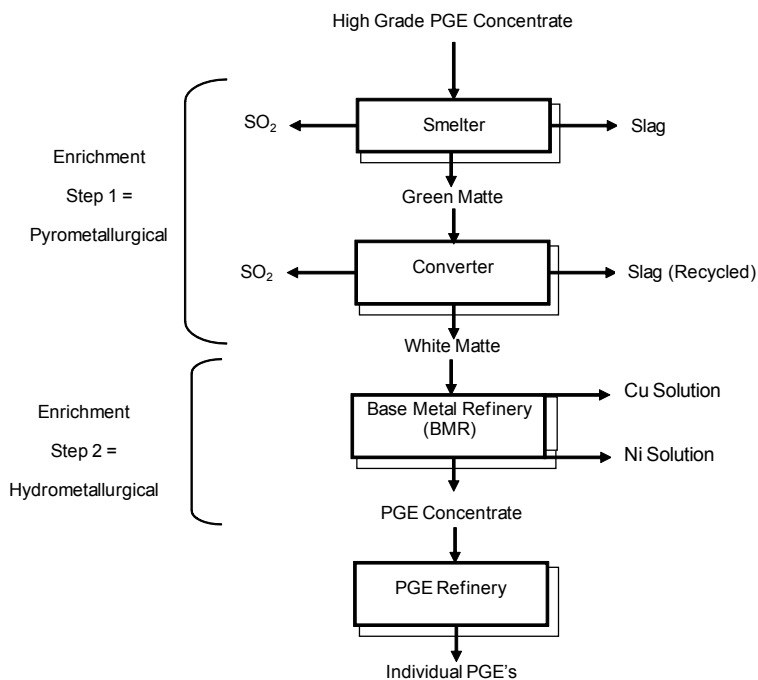

Figure 8. Simplified Flowsheet of Hartley Platinum Base Metals Refinery

**Hydrometallurgical Enrichment - The Base Metals Refinery**

The hydrometallurgical enrichment step consists in a reverse leaching operation whereby most of the accompanying minerals (copper, nickel, cobalt and iron sulphides) are dissolved to leave behind an upgraded PGE concentrate for the PGE refinery.

The process to be used in the PGE's refineries has to meet the following two objectives:

- dissolve as much as possible the metal sulphides without dissolving the PGE and,
- to effect as complete as possible a separation between the copper and the nickel so that these two metals can be recovered efficiently and generate marketable products.

The same processes, as used in the nickel and copper-nickel refineries, are being used for the PGE base metal refineries (Kerfoot, 1986). For the high-grade PGE refineries, there are essentially two processes used commercially, the Outokumpu process and the Sherritt Gordon process. The chemistry underlying both processes is the same.

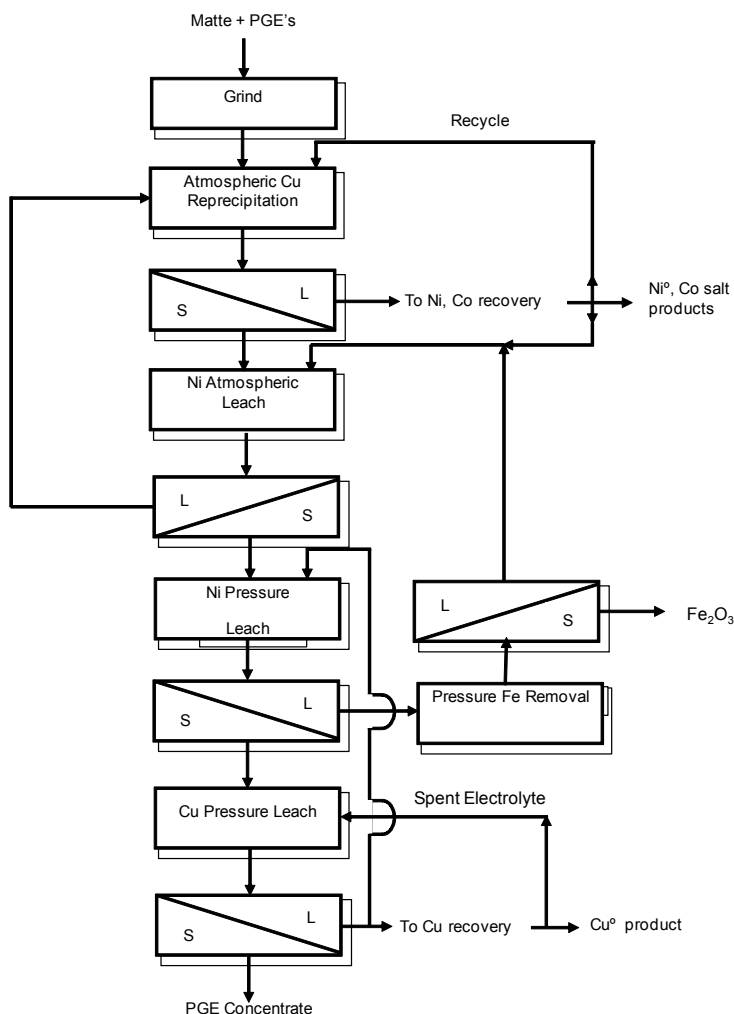

Figure 9. Simplified Flowsheet of Rustenburg Base Metals Refinery

Table 9. PGE Matte Refineries in the Western World

PGE MATTE REFINERY	MATTE COMPOSITION					BASE METAL LEACH PROCESS			
	%Ni	%Cu	%Fe	%S	%PGE	TYPE	OXIDANT	TEMP (°C)	PRESSURE (kPa)
STILLWATER	42.5	28.1	3.1	22.6	2.1	S	O2	Amb-135	Atm- 1000
HARTLEY*	44	33	1.0	21	0.15	O	O2	85-150	Atm-unknown
IMPALA	50	28	1.0	20	0.15-0.2	S	Air	135	900
RUSTENBURG	47	22	3.0	21	0.15-0.2	S	Air	135	1000
WESTERN PLATS	48	28	0.5-1	21	0.15-0.2	S	O2	85-165	At-1100

S = Sherritt Process; O = Outokumpu; Amb = ambient; Atm = atmospheric  
 \*Not operating at present

The only PGE base metal refinery using the Outokumpu process was that of Hartley Platinum, in Zimbabwe. That refinery is no longer in operation (Chadwick, 1996; Fugleberg, 1995). A simplified process flowsheet of the Hartley Platinum BMR is illustrated in Figure 9.

All of the other PGM Base Metal refineries in the Western World use the Sherritt Gordon process. A typical example is the process used at the Rustenburg Base Metal Refiners, in South Africa, as presented in Figure 10.

A simplification of the Sherritt process is operated at the Stillwater refinery, as shown in Appendix 4, whereby no attempt is made to separate the nickel and the copper, and a bulk Ni-Cu solution is shipped to an outside nickel refinery (Newman, Makwana, 1997; Kolstad, Newman, 1998).

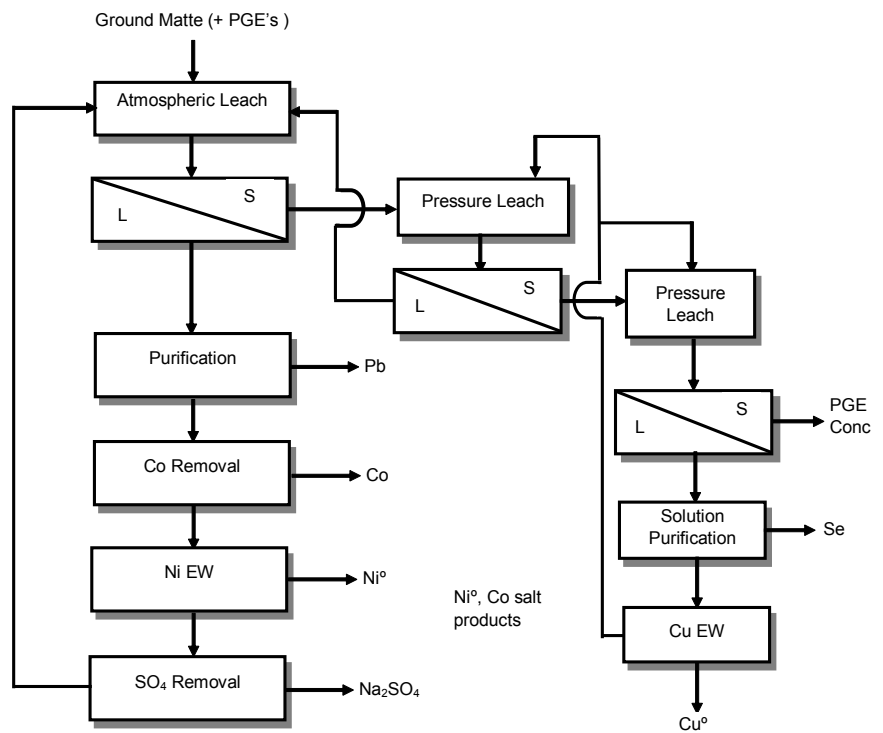

Figure 10. Noril'sk Complex - Existing Refining Process, Simplified

Detailed description of these processes have been published (Brugman and Kerfoot, 1986; Hofirek and Kerfoot, 1992; Hofirek and halton, 1990). Both processes have the same rationale and operate in several steps of increasingly more aggressive conditions.

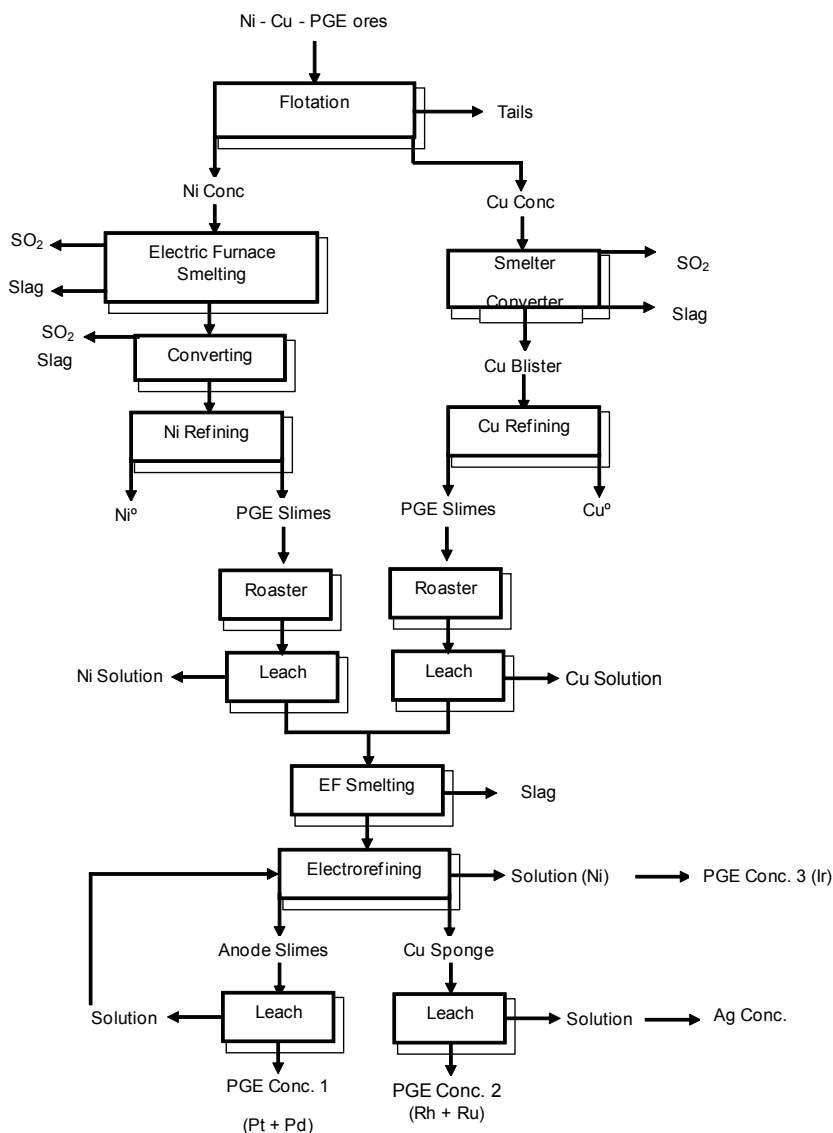

Figure 11. Noril'sk Complex - New Base Metals Refining Process, Simplified

The initial stage operates under mild conditions to leach some Ni and Co, and uses fresh matte to remove Cu from the nickel sulphate solution; the central stage(s) operates under harsher conditions and aims at dissolving all the nickel and some copper from the matte; the final stage aims at dissolving all the remaining copper and some iron from the matte.

The detailed chemistry of the base metals refinery is outside the scope of this review and has been described by several authors (Brugman, Kerfoot, 1986; Hofirek, Kerfoot, 1992; Hofirek, Halton, 1990). It will only be discussed here briefly.

The major constituents of the matte are a non-stoichiometric copper sulphide djurleite (Cu<sub>1.96</sub>S) and heazlewoodite (Ni<sub>3</sub>S<sub>2</sub>).

The nickel stream is neutralised and decopperized using matte. The reactions involved are:

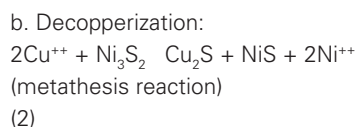
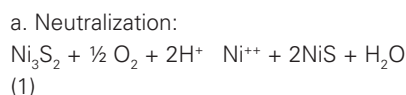

and

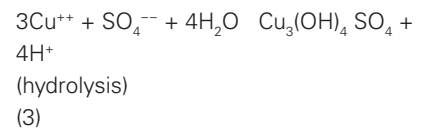

These reactions provide a neutralised, iron and copper-free (pH 6.0, <10 mg/L Fe, Cu) suitable for the recovery of nickel metal and a cobalt product.

c. Iron removal: iron can be removed during the decopperization step (atmospheric) as butlerite:

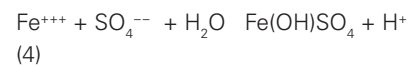

or during a special high temperature step, as hematite:

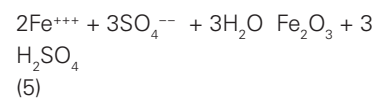

The copper stream solution undergoes a selenium-removal stage, that also removes any co-dissolved PGE, and then is processed to copper metal in a conventional electro-winning plant.

Table 9 summarises production data for the main high PGE matte refineries in the Western world, collected from various sources.

**Noril'sk**

The Mining and metallurgical company, Noril'sk Nickel (MMC Noril'sk Nickel), is one of the largest producers of nickel and PGE in the world. Noril'sk has operated a metallurgical complex to treat their ores for many years. The present process is illustrated in Figure 11, as described recently (Ter-Oganesyants et al., 2000).

The PGE are recovered in the anodic slimes from both the nickel and the copper circuits. The slimes are roasted and leached separately to recover the nickel and the copper, respectively; the leach residues are then combined in an electric furnace, wherefrom anodes are electrorefined; the anode slimes are leached in sulphuric acid to generate a PGE concentrate #1 containing 60-65% (Pt + Pd); the copper spongy precipitate is also leached in sulphuric acid to generate a PGE concentrate #2

containing 2.5-3.5% (Rh + Ru); finally, the spent electrolyte, containing mainly nickel sulphate, is treated to precipitate a PGE concentrate #3 assaying 10-20% Ir.

This process recovers higher than 99% of the major PGE's (Pt + Pd), but it has a long processing cycle for the slimes (30 days), a large amount of material in progress and is not very flexible for processing other PGE feed materials.

A new process has been developed in-house by Noril'sk Nickel to overcome the shortcomings of the present operation and make use of the most modern technology (Shestakova et al., 2000). Several major modifications are being incorporated at the flotation plant, the smelter and the "Base Metals Refinery".

At the flotation plant, a bulk Cu-Ni concentrate will be produced, and the new mill is now being constructed by Outokumpu Oy on behalf of Noril'sk.

At the smelter, a high copper converter matte will be produced, with a copper-to-nickel ratio of about 2:1; the matte will be granulated, wet-ground and then treated in the new base metal refinery, that will be using a new sulphuric acid leaching technology composed of:

- an atmospheric decopperization process whereby matte is used to decopperize the nickel anolyte
- atmospheric iron hydrolysis using nickel or sodium carbonate (under oxidising conditions)
- an oxidising pressure leaching stage, followed by autoclave refining of the copper concentrate
- maintaining the sulphur balance by treating a bleed of the nickel anolyte with sodium carbonate to produce nickel carbonate and a sodium sulphate effluent

This new process will result in a copper concentrate containing all the copper (70-71% Cu grade), little iron (0.2-0.6% Fe), little nickel (0.4-0.7% Ni), 26-28% S and practically all of the PGE (plus gold).

This concentrate will be autogeneously smelted in Vanyukov furnaces to copper blister at the Nadezhda smelter, and the precious metals recovered in the anode slimes during electrorefining of the copper blister.

A simplified flow diagram of the new enrichment process is illustrated in Figure 11.

Significant improvements will also be incorporated in the new PGE Refinery:

- Pressure leaching will be used to process the copper anode slimes (and the nickel anode slimes).
- Refinery wastes (rich in Rh), used catalysts and gravity concentrates, will also be treated in separate lines.
- All resulting PGE concentrates will be blended and smelted to matte in a Kaldor furnace.
- The resulting matte will be pressure leached, and eventually will produce a silver concentrate (AgCl), a PGE concentrate #1 (Pt + Pd) as leach residue, and a PGE concentrate #2, by precipitation with thiourea and refining to 35% (Rh + Ru + Ir).

With this process, the slimes processing cycle will be reduced to four days. A simplified flow diagram of the new PGE refinery is presented in Figure 13.

#### Treatment of Placer Concentrates

Russia is the leading producer of placer platinum with 10t Pt produced in 1997, representing half of its Pt production from all sources (Valtikh et al., 1999). One of the major sources of iridium in Russia is from placer platinum concentrates, assaying 70-84% Pt, 1.7-9.2% Ir, 0.3-0.7% Pd, 0.4-0.6% Rh, 0.2-2.5% Os, 0.2-6% Au, 10-14% Fe and other base metals (Cu, Ni). Other major sources are the iridium-rich PGE concentrate from Noril'sk, and recycled material (used crucibles, scrap) (Timofeyev et al., 2000). Placer concentrates are presently treated at the Krasnoyarsk Refinery, together with Noril'sk iridium by-product, using only hydrometallurgical techniques

(chlorination). A new process to treat the placer platinum concentrate to maximise iridium and osmium recovery was developed by the Ekaterinburg Nonferrous Metal Processing Plant. It is described in Figure 14.

Placer concentrates would be processed in a series of steps:

- oxidizing roast plus smelting
- gases treated to recover osmium
- the metallic phase completely dissolved
- gold recovery first, followed by successive recovery of Pt, Pd
- iridium recovery and purification (pyrometallurgical)
- rhodium recovery and purification (molten salt)



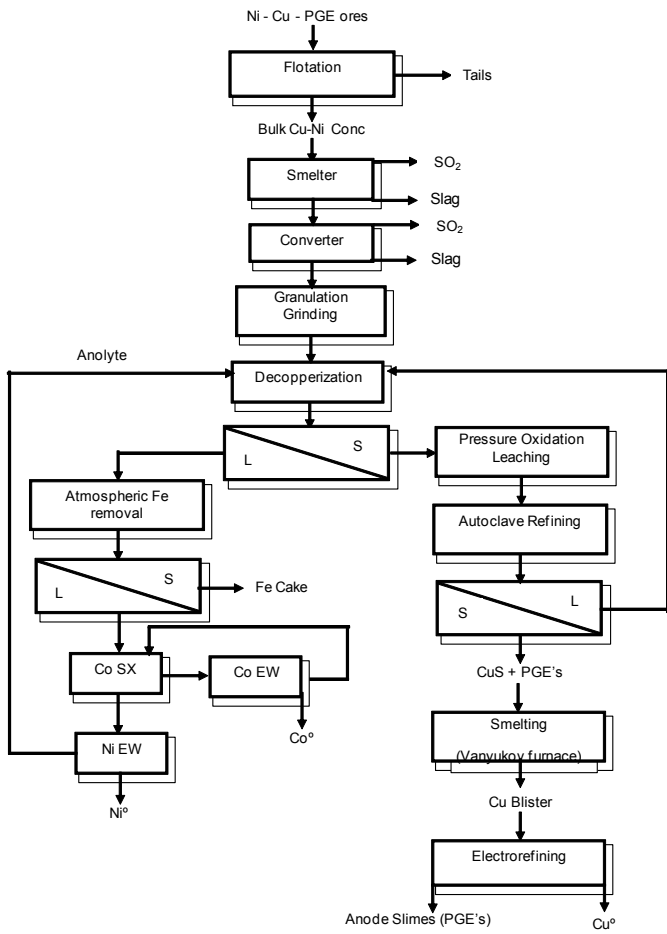

Figure 12. Noril'sk Complex - New PGE Recovery Process - Simplified

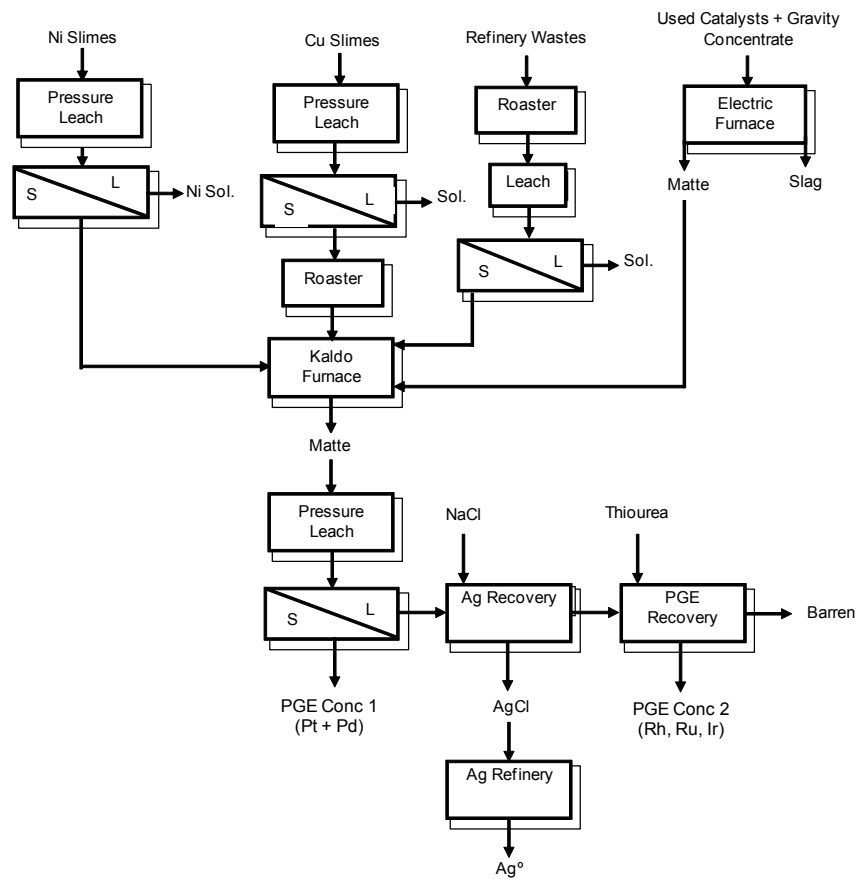

Figure 13. New Treatment Process for Placer Platinum

**Lower PGE Grade Sources**

There are other significant PGE producers treating lower grade feedstock materials such as, for example, Inco and Falconbridge. As opposed to the PGE producers discussed previously, the PGE, although significant contributors to the overall economics of these operations, are nevertheless a by-product of nickel (mostly), copper and cobalt. The process is, therefore, designed around the major metal (nickel), while also maximising PGE recovery.

**Inco**

The Inco process for the treatment of its Sudbury ores has been well described (Wiseman et al., 1988; Tyroler et al., 1988). Figure 15 summarises it and indicates how the PGE high grade concentrate(s) are produced.

Starting from a low PGE grade (1 g/t PGE) in the mixed ore, Inco produces refined nickel and copper and by-product precious metal concentrates, as anode slimes and carbonyl process residues. The residue from the carbonyl process assays 55-60% Cu, 6-10% Ni, 4-8% Co, 4-9% Fe, 13-19% S, 600-900 g/t (Au + PGE) and 750 - 1350 g/t Ag. It is treated in a two-stage pressure leaching process to dissolve first the nickel and the cobalt, and then the copper + selenium + tellurium. PGE concentrate from the nickel circuit contains 60-80% (PGE + Au), plus some silver and a variety of base metals such as tellurium, antimony, tin, lead, bismuth, copper, nickel and iron. Concentrate from the copper circuit is largely palladium and platinum, with some rhodium, and generally much less base metals than the concentrate from the nickel anode slimes. These concentrates are refined in the Inco's Acton refinery in the UK, as will be discussed later.

**Falconbridge**

Falconbridge in Sudbury treats ores similar to Inco's but the approach to recover base metals and the PGE is completely different (Hougen et al., 1975, Stensholt et al., 1988; Stensholt et al., 1986, Stensholt et al., 2001). The Falconbridge process to recover PGE from its ores is presented in a simplified form in Figure 16.

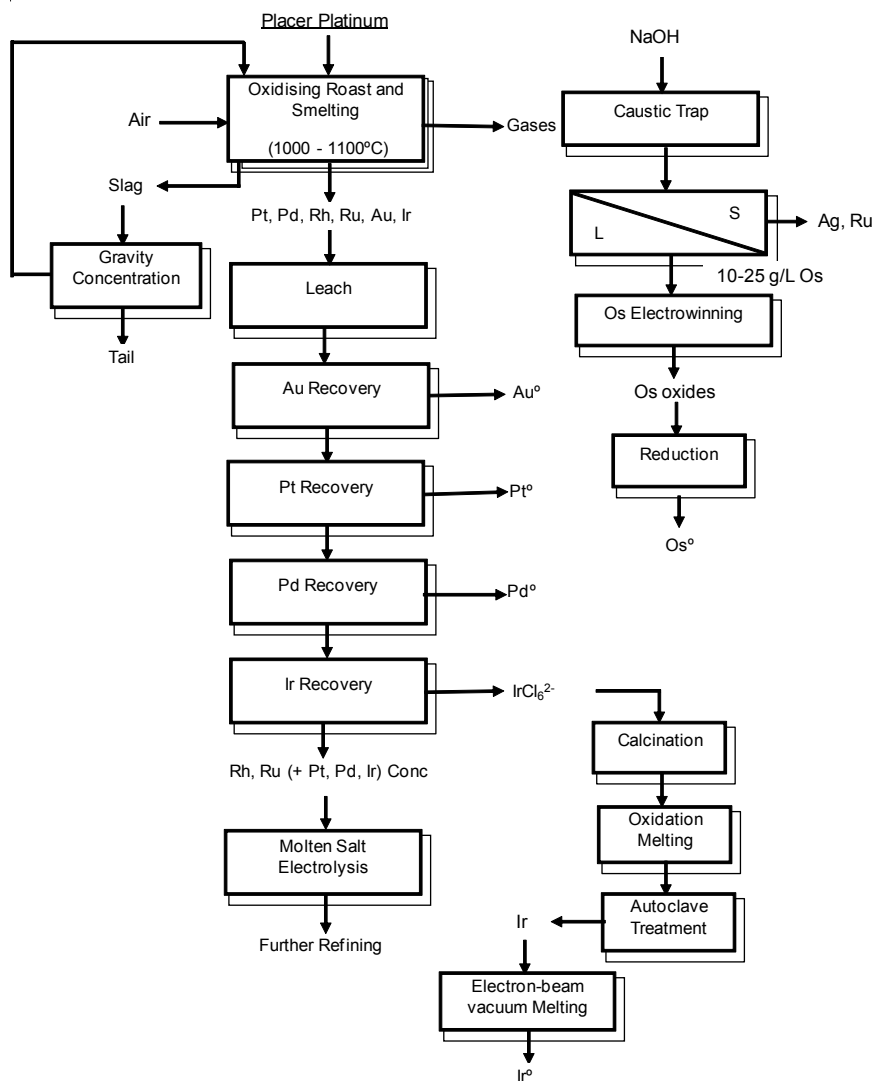

Figure 14. Recovery of PGE's during Inco's Treatment of Sudbury Ores

The nickel and the cobalt are fully recovered to pure metals from a chloride system; the copper is roasted to sulphates and recovered conventionally from sulphate solutions. The PGE are concentrated in the sulphuric acid leach residue. The residue is reduced to metal using hydrogen, and leached with chlorine under controlled redox potential to minimise the dissolution of PGE's. The solid residue is the primary PGE concentrate; it is smelted to matte in an electric furnace; the matte is granulated and leached with HCl/Cl<sub>2</sub> to obtain the final PGE product.

**Copper Smelters**

Most copper concentrates contain small, but not insignificant, quantities of PGE. These eventually find their way, together with gold and silver, into the copper refinery anodic slimes. Most large copper refineries, therefore,

normally operate a precious metal plant where anodic slimes are treated. Those slimes also contain significant amounts of selenium and tellurium. The process used can vary from plant to plant. Three examples will be briefly presented.

**Noranda CCR Refinery**

In 1998, Noranda CCR Division commissioned a new anode slimes treatment plant (Lessard, 1989; Bilodeau et al., 1987; Morrison, 1989; Morrison, 1985). At that time, the plant process was as simply illustrated in Appendix 5.

The process to recover gold from the Moebius cell mud had remained largely unchanged since the 1930's. Disadvantages of this process were the large (30%) circulating load of Pd through the acid leach of gold mud from the Moebius cell, and significant gold in-process inventory.

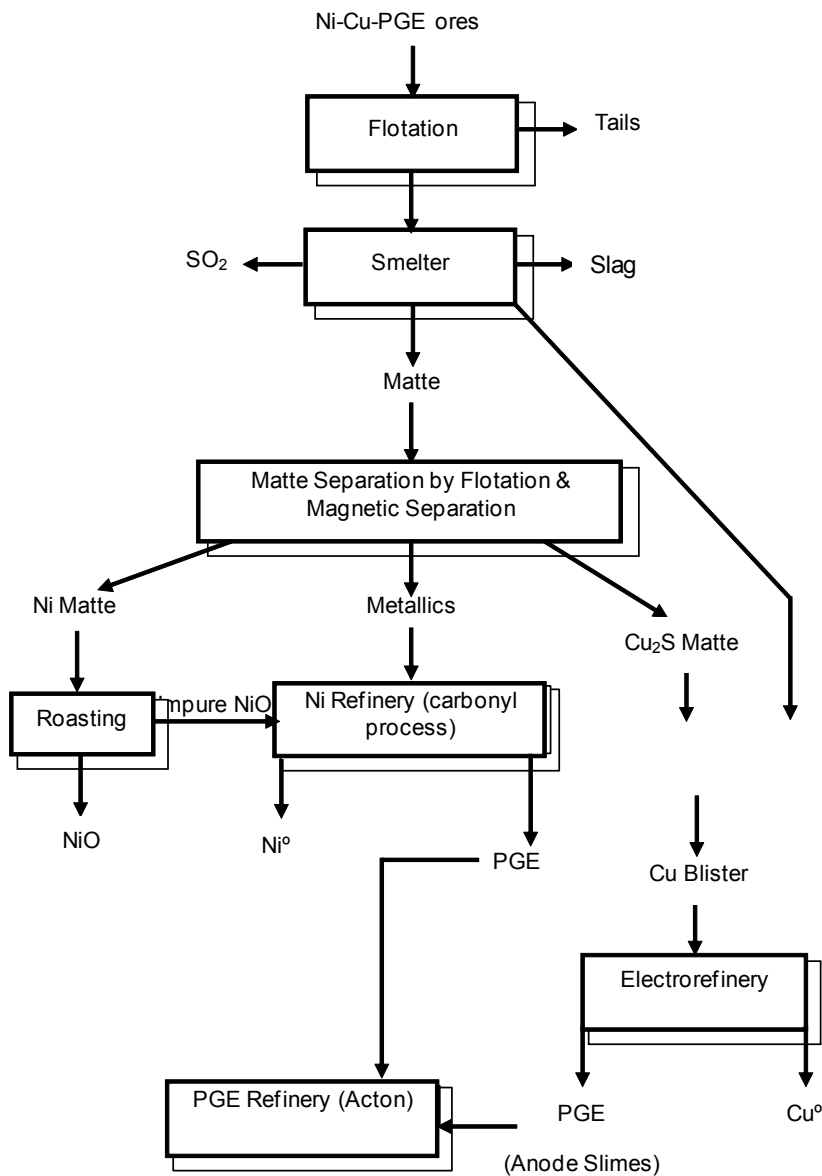

Figure 15. Falconbridge Chlorine Process to Recover Ni, Cu, Co and PGE's

A new process, developed at the Noranda Research Centre, has been installed to overcome these problems. A simplified process flowsheet of the new installation is illustrated in Figure 17.

The incoming gold mud typically assays 45% Au, 35% Ag, 14.2% Pd, 1.5% Cu and 0.5% Pt. The new process generates 99.99% Au, a 90% Ag cement for recycling to the Dore furnace, and a Pd/Pt concentrate assaying 90.8% Pd, 3.2% Pt, 2% Cu, 1.35% Pb and 0.66% Se. In 1988, the silver refinery produced 801 tonnes of silver bullion, 26.6 tonnes of gold and 3.85 tonnes of Pd/Pt concentrate.

**The Outokumpu Pori Refinery**

The process used at Pori (Hyvärinen et al., 1984) is summarised in Appendix 6.

The electrolyte slimes undergo a series of stages:

- decopperizing by oxidation leach, followed by filtration
- nickel removal by pressure leaching at 160°C
- selenium removal from the slimes, followed by Dore smelting of the resulting slimes, electrolytic silver refining in a Moebius cell
- gold mud is further purified (H<sub>2</sub>SO<sub>4</sub> leach) then dissolved in Aqua Regia
- gold is recovered from solution by reduction (Na<sub>2</sub>SO<sub>3</sub>)

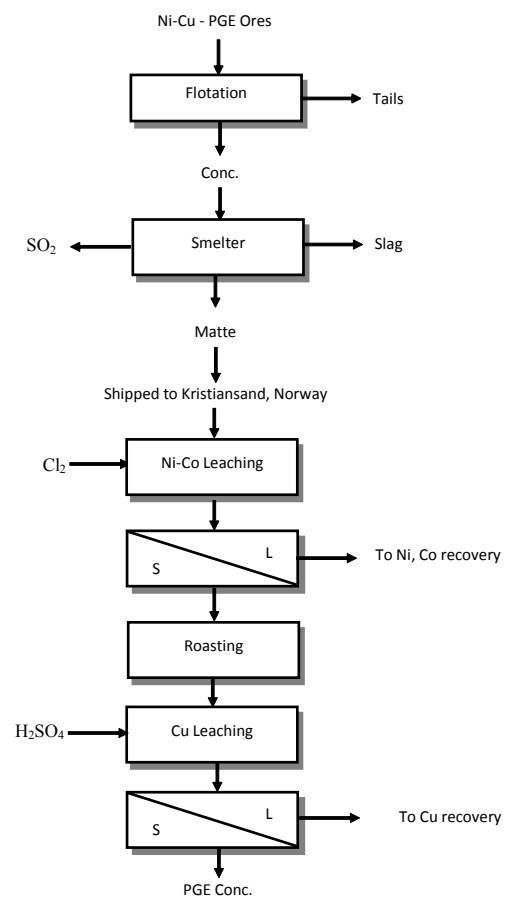

Figure 16. New Hydrometallurgical Process to Treat CCR Anode Slimes - (Simplified)

- PGM's are cemented with iron to produce a 45% Pt, 45% Pd sponge.

In 1983, Outokumpu Pori refinery produced 38 tonnes of silver, 1.1 tonnes of gold, and 2000 kg of Pt/Pd sponge (45% Pt, 45% Pd).

**Phelps Dodge El Paso Refinery**

The new refinery recently commissioned to treat Phelps Dodge's anodic slimes has been described in detail (Hoffmann, Wesstrom, 1994). The process is illustrated in a simplified form in Figure 18.

This is a very elegant process based on an early separation of the silver (the main constituent) from the rest of the precious metals, and gold solvent extraction.

The silver leaching step is based on the metathesis reaction:

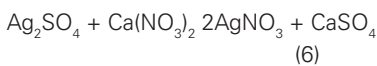

The calcium nitrate is produced by reacting hydrated lime to consume nitric acid generated at the anode, as per the reaction:

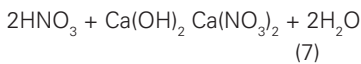

Very pure products are achieved using this new process, 99.95% and 99.995% for silver and gold, respectively. After 2 years of operation, Phelps Dodge refinery was producing 3.1 M Tr. oz Ag, 86.000 Tr. oz Au, 2,000 Tr. oz Pd and 200 Tr. oz Pt.

**Secondary Sources: High Grade Recycled Products - Auto Catalysts High Grade Products Auto Catalysts**

Automobile catalytic converters ("catalysts") are used to convert pollutants in automobile exhaust into water vapour, carbon dioxide and nitrogen. Considering the size of the automobile market and the emission regulations, this represents a major new source of the PGE, and recycling used auto catalysts is becoming a significant source of PGE.

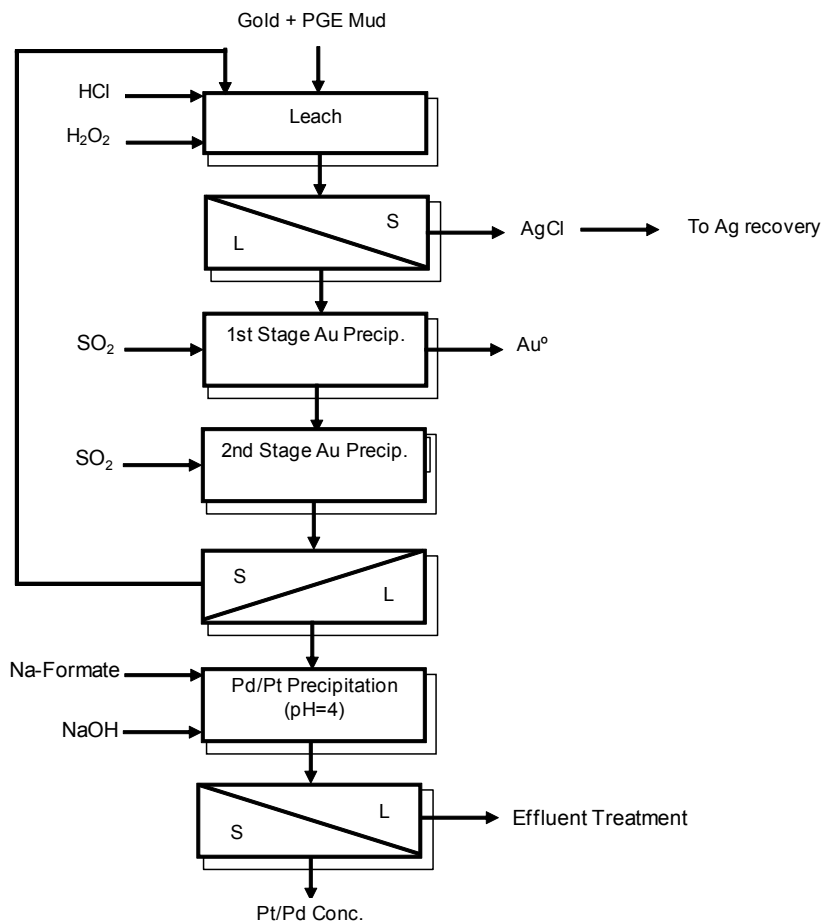

Figure 17. Simplified Process Flowsheet for Phelps Dodge Slimes Refinery

In 2000, 460,000 oz. of Pt and 230,000 oz of Pd were recovered, mostly in North America, from recycled auto catalysts (8.5% and 2.9%, respectively, of the total supply).

Auto catalysts are generally available in one of two forms, pellets or monolith ("honeycomb"). The pellets substrate (spheres or extrudes) is 100% -alumina; monolithic catalysts employ a gel or wash coat of -alumina on top of the honeycomb structure; the latter is composed of cordierite (2MeO.2Al<sub>2</sub>O<sub>3</sub>.5SiO<sub>2</sub>, where Me is either Fe or Mg). The catalyst itself could be two-way (Pt + Pd) or three-way (Pt + Pd + Rh).

Table 10 illustrates the composition of typical autocatalysts (Ferron et al., 2001, Tucson). Sample A is a virgin monolithic catalyst, while Samples B and C are samples of used catalyst.

Because of their high value (at 1000 g/t PGE, assuming an average price of US \$350/oz, a metric tonne of catalyst is worth US \$11,550), the retreatment of used catalysts has attracted much attention. In 1988, several processes had been identified to recover the PGE's from auto-catalysts (Hoffmann, 1988; Mishra, 1988). These were:

- complete dissolution of the substrate in sulphuric acid to obtain a high-grade PGE residue for further treatment
- dissolution of the -alumina substrate followed by HCl/Cl<sub>2</sub> dissolution of the PGE's away from the inert cordierite structure
- dry chlorination
- plasma fusion
- copper collection in dedicated smelters
- copper smelters

The processes most likely to succeed are the treatment of autocatalysts in conventional copper smelters, since no incremental capital costs are incurred. Recently published information has

described the operation of the new Degussa dmC<sup>2</sup> refinery in Hanau, Germany (Hagelüken, 2001).

The process used for the treatment of autocatalysts is illustrated in Figure 19.

The reduction furnace slag contains 10-50 g/t PGE and is recycled to the copper smelter. The Cu metal from the furnace contains 10-15% PGE, and contains also iron and nickel.

**High Grade Products - Mint Residue**

Residues from national mints do contain significant PGE. Such an example is given by a Brazilian mint residue assaying 13.6% Cu, 2.2% Fe, 1.6% Pb, 8.3% S, 35.6% Pd, 0.9% Pt and 0.1% Au. The process developed by the Centre for Mineral Technology (CETEM) and industrially applied is illustrated in Figure 20 (Sobral, Granato, 1992).

The process used includes:

- dilute H<sub>2</sub>SO<sub>4</sub> leaching to remove Cu, Fe
- concentrated HNO<sub>3</sub> leach to dissolve Pd (but not Pt, Au)
- base metals precipitation (NH<sub>4</sub>OH)
- yellow salt precipitation
- reduction with hydrazine to produce the Pd powder

The purity of the palladium so produced exceeds 99.95%.

**Recovery of Iridium from Zircon Crucibles**

The refining of PGE is mostly based on the formation of chloro-complexes, but other chemistries are also available such as phosphates or fluorides (Patrushev, 1998; Izatt et al., 1987). It is known that iridium metal can be oxidised to form soluble fluorocomplexes, as per the overall reaction (Mitkin, 2000):

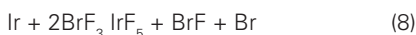

This property can be used to recover iridium from ceramic zirconium (Y Al<sub>2</sub>O<sub>3</sub> stabilized) blocks serving to produce iridium crucibles, as indicated in Appendix 7.

In the process suggested, the iridium-contaminated zirconium block (0.8-1.2% Ir) was oxidized to iridium (V) using halogen fluoride (KBrF<sub>4</sub>); after separation

Table 10. Chemical Analysis of Typical Autocatalysts

ELEMENTS	VIRGIN	USED	
	MONOLITHIC	PELLETS	MONOLITHIC
SiO <sub>2</sub> (%)	40.9	0.1	35.3
Al <sub>2</sub> O <sub>3</sub>	43.7	91.1	40.3
MgO	10.8	0.1	9.8
Fe <sub>2</sub> O <sub>3</sub>	1.0	0.8	1.4
P <sub>2</sub> O <sub>5</sub>	0.04	0.48	0.61
MnO	0.02	1.23	2.09
Pb (g/t)	<50	1500	550
Pt (g/t)	623	322	1071
Pd (g/t)	431	134	-
Rh (g/t)	-	-	45

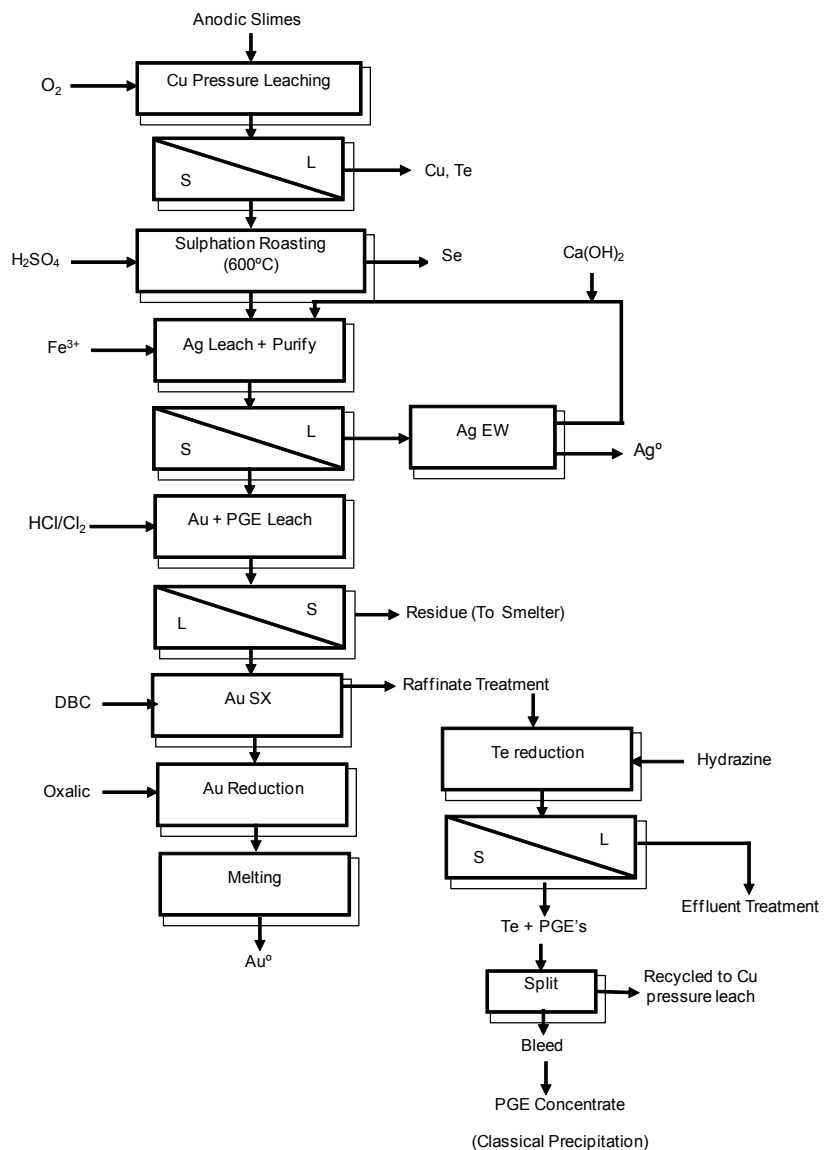

Figure 18. Degussa dmC<sup>2</sup> Process to Recover PGE's from Autocatalysts

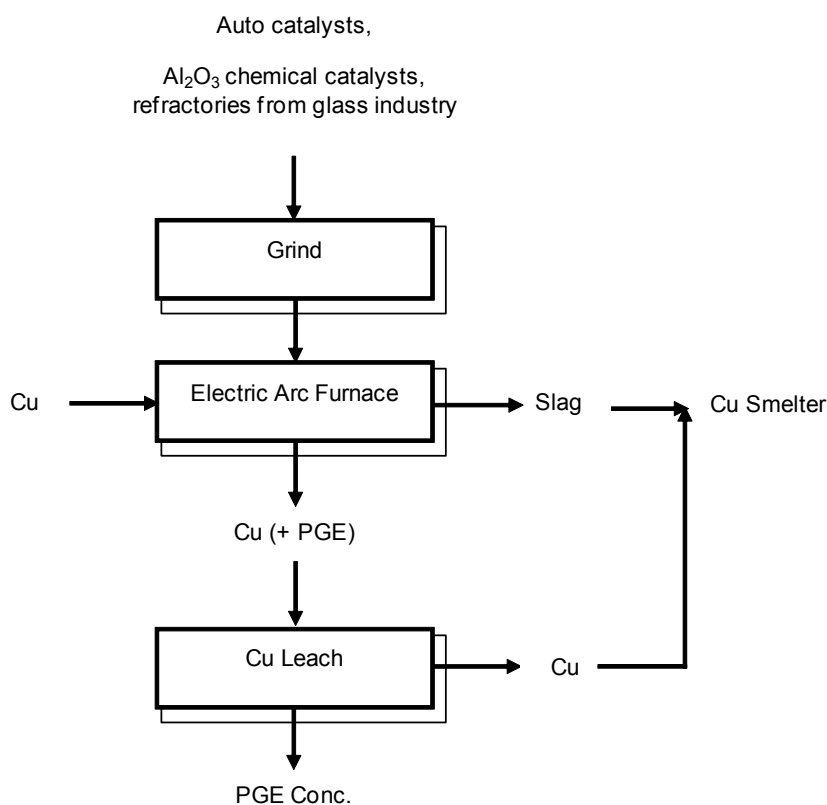

Figure 19. Brazilian Mint Process Flowsheet to Recovery Pd

of the iridium fluoride formed (IrF<sub>5</sub>) from the zirconium block, the solution was treated with HCl to form the K<sub>2</sub>IrCl<sub>6</sub> hexachloroiridate (IV).

Using this process, iridium recovery from the zirconium block was 98-99%.

#### Low-Grade Products: The Recycling of Electronic Scrap

Electronic scrap is normally recycled to copper smelters, and therefore its precious metals content is eventually recovered within the Cu refinery anodic slimes (Beke, 2001).

There are plants, however, primarily dedicated to the treatment of electronic scrap. One such plant was the US Metals Refining Company (Amax) plant in Carteret, New Jersey (Fruh, 1986; Manzone, Opie, 1977). About two-thirds of the 210,000 T/y copper produced by USMR originated from scrap. The process can be described as illustrated in Figure 21.

The treatment of copper scrap consisted of:

- copper smelting and converting
- copper electrorefining
- anode slimes purification by H<sub>2</sub>SO<sub>4</sub> leach (to remove Cu + Ni)
- Dore smelting and silver electrorefining in a Thum cell
- gold mud leaching with Aqua Regia
- gold reduction with SO<sub>2</sub>
- selective precipitation of red and yellow salts

When the amounts of PGE (Ir, Ru, Rh) were such that they would become insoluble in the anodes, they were cast and treated batchwise in a separate circuit; the silver was recycled to the main circuit, and the sludge was boiled in aqua regia to solubilise Au, Pt, and Pd. The residue containing Ir, Ru and Rh was melted with Pb; the Pb-Rh alloy was leached with nitric acid to dissolve the Pb, and the crude rhodium purified. The (Ir+Ru) rich nitric acid leach residue was fused with sodium peroxide to leach the Ru, while the residue was chlorinated and purified via the classical route to Ir powder (Hoffmann, pers. Comm.).

#### THE REFINING OF PGE CONCENTRATES

The final refining step consists in transforming the high-grade PGE concentrate (30-60% PGE) into high purity (>99%) individual elements (Pt, Pd, Ir, Os, Ru, Rh), as well as recovering the gold and silver usually accompanying the PGE.

Several papers describing the chemistry and principles underlying the refining of the PGE have been published (Edwards, 1976; Demopoulos, 1989; Foo, 1982). The success of the refining step is based on manipulating, both from a thermodynamic and kinetic point of view, the complex aqueous chloride chemistry of the PGE. Table 11 presents a list of the most common chloro-complexes of the precious metals, for each of their oxidation states.

The relative abundance and stabilities of these complexes depend on several factors of which the most important are the redox potential and the concentration of chloride ion.

#### Classical Refining

The methods developed many years ago to extract, separate and refine the various platinum group metals are based on analytical chemistry principles. The classical process circuit was initially developed to treat electrolytic slimes; it is rather complex and is, in practice, based on aqua regia solubilization followed by successive steps of salt precipitation and redissolution, followed by thermal reduction to metal.

A few of the key properties (thermodynamic or kinetic) commonly used to separate the various precious metals are presented below:

- AgCl is insoluble
- AuCl<sub>4</sub><sup>-</sup> is easily reduced to Au<sup>0</sup> (fast kinetics and large thermodynamic driving force).
- PtCl<sub>6</sub><sup>2-</sup> is very stable versus hydration, unless Pt(II) is present
- PdCl<sub>4</sub><sup>2-</sup> is the most labile of all PGE chloro-complexes, readily undergoing ligand exchange reaction of the type: PdX<sub>n</sub> + L → PdX<sub>n-1</sub>L + X, where X = complexing radical and L = Ligand
- RhCl<sub>6</sub><sup>2-</sup> is the least stable of all PGE chloro-complexes, easily undergoing hydration both from kinetic and

thermodynamic points of view.

- Ammonia readily forms insoluble salts or compounds with various PGE chloro-complexes, such as  $(NH_4)_2PtCl_6$ ,  $Pd(NH_3)_2Cl_2$ ,  $(NH_4)_2IrCl_6$ ; this property is commonly used to separate the different platinum-group metals.
- $RuO_4$  and  $OsO_4$  (oxidation states + 8) are stable and can be separated from the other PGE's by distillation of their tetroxides.

The classical refining process used for many decades by Inco at their Acton refinery in the UK is illustrated in Figure 22 and Figure 23. Details have been published elsewhere (Demopoulos, 1989).

In a very simplified form, the classical process previously used at Acton can be described as:

- Aqua Regia dissolution of Au, Pt, Pd
- gold recovery from solution by reduction
- precipitation of  $(NH_4)_2PtCl_6$  and purification to Pt metal
- precipitation of  $Pd(NH_3)_2Cl_2$  and purification to Pd metal
- lead smelting of Aqua Regia residue
- nitric leaching of silver, lead
- bisulphate fusion of nitric leach residue to solubilize and recover Rh
- peroxide fusion of residue to solubilize Os, Ru, followed by precipitation of  $RuO_2$  with ethanol and purification to Os, Ru metals
- purification of residue to Ir metal

The process described in Figure 22 and Figure 23 has been used for decades and is still in use, partly or totally, in various locations. It is rather complicated, however; it gives a poor first time yield of refined metals and requires lengthy refining times (up to 6 months for rhodium). It also results in significant inventory or in-process of PGE, affecting the overall economics of PGE refining because of the high cash value of the metals that are held up.

**Modern PGE Refining**

Because of the factors described above, the industry was forced to introduce new separation technologies, namely solvent extraction (Barnes, Edwards, 1982; Anon, 1979; Rimmer, 1989; Cleare et al., 1979; Cleare et al., 1981;

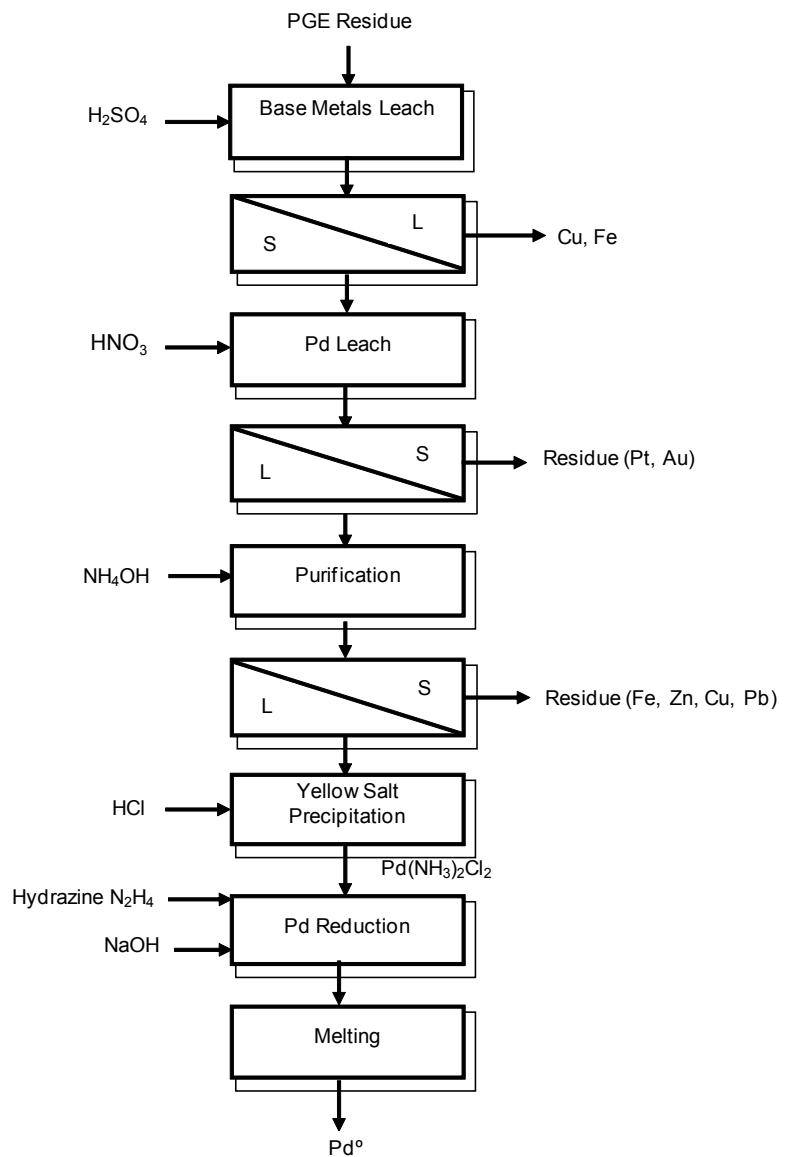

Figure 20. Recovery of PGE from Electronic Scrap at USMR Carteret Plant

Table 11. Most Common Chlorocomplexes of the Precious Metals

PRECIOUS METAL	OXIDATION STATE	MAJOR CHLORO COMPLEXES
Silver	I	$AgCl$ , $AgCl_2^-$
Gold	III	$AuCl_4^-$
Platinum	II IV	$PtCl_4^{2-}$ $PtCl_6^{2-}$
Palladium	II IV	$PdCl_4^{2-}$ $PdCl_6^{2-}$
Iridium	III IV	$IrCl_6^{3-}$ $IrCl_6^{2-}$
Rhodium	III	$RhCl_6^{3-}$
Ruthenium	III	$RuCl_6^{2-}$
Osmium	III IV	$OsCl_6^{3-}$ $OsCl_6^{2-}$

Edwards, 1977; Demopoulos, 1986; Reavill, Charlesworth, 1990). Due to the selectivity and efficiency of the solvent extraction process, several refineries have opted for a total leach approach followed by a sequential metal with the aid of solvent extraction.

There are three mechanisms by which solvent extraction of a metal species can occur (compound formation, ion-pair formation and solvation). All three mechanisms are encountered in PGE solvent extraction, with ion-pair formation by far the most important.

Table 12 from (Demopoulos, 1989) summarises data for the commercial application of solvent extraction for the refining of precious metals.

Detailed information about the modern refining schemes used at three of the world's largest PGE refineries (Inco, MRR, Lonrho) has been published (Demopoulos, 1989). More recent information is lacking, and so is information on the Krasnoyarsk refinery in Russia, where most of Russia PGE are refined.

The process used at Acton by Inco is presented in a simplified form in Figure 23 (Barnes, Edwards, 1982): gold solvent extraction was introduced first in 1971 and, following its successful application, work was undertaken to investigate the applicability of SX to the separation of the other precious metals in solution.

**Refining of Iridium**

During the treatment of placer-type PGE concentrate, iridium is recovered as an impure product ((NH<sub>4</sub>)<sub>2</sub>IrCl<sub>6</sub>) assaying 31.33% Ir, 5.02% Pd, 1.44% Rh, 0.45% Pt. Classical methods will produce high-purity iridium (for example by precipitating the other PGE's ([Pd, Rh, Pt] using H<sub>2</sub>S) but require complicated equipment and iridium hold-up in intermediate products is large. Another approach, based on electrochemical techniques, has been proposed to refine iridium (Ermakov et al., 2000). The process is presented in Appendix 8.

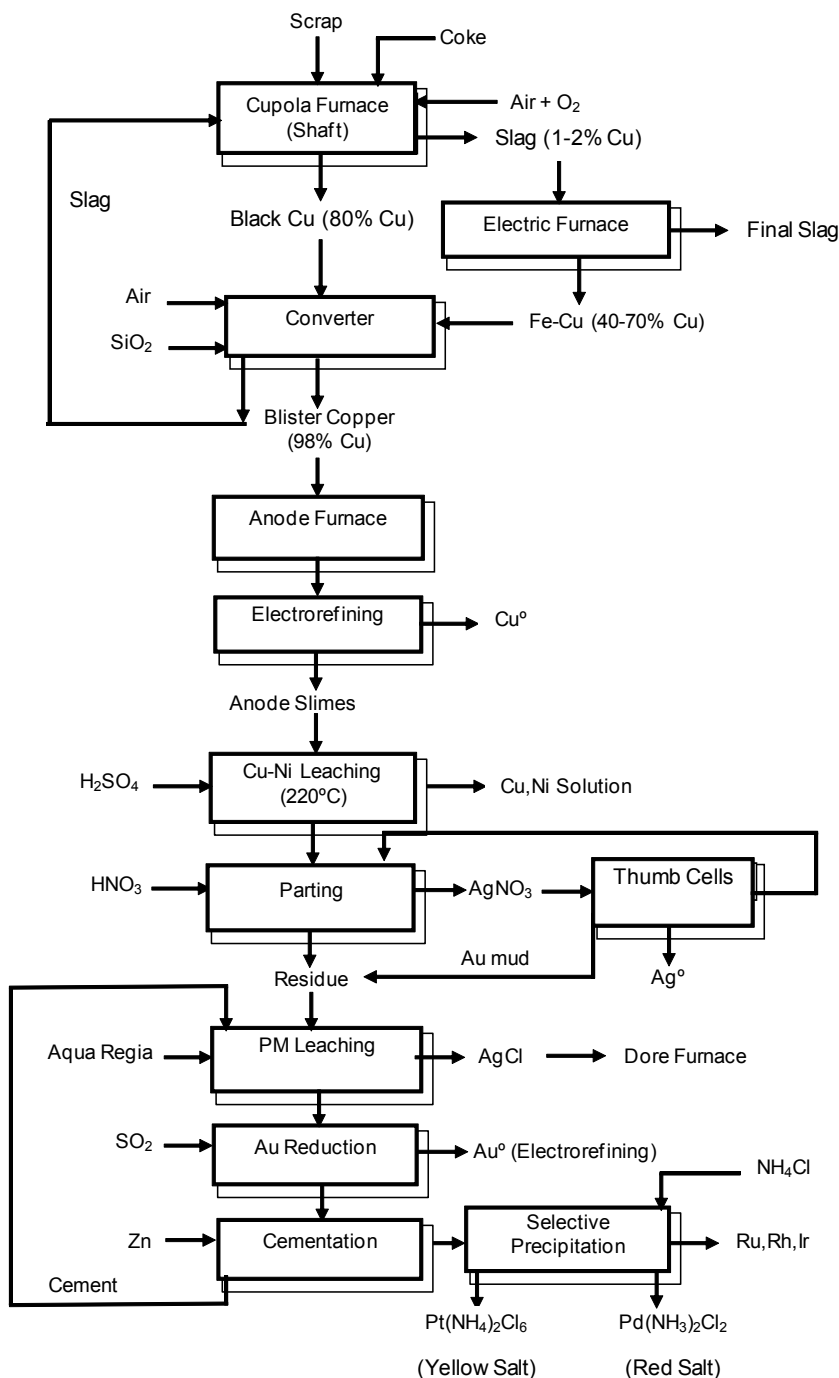

Figure 21. Classical Refining Process for Au, Pt, Pd - Inco Acton Refinery



**NEW TRENDS DEVELOPING**

**Smelting and Base Metals Refinery  
Smelting of High Chromite Concentrates (UG2)**

In the South African Bushveld, significant PGE reserves lay within the high-chromite UG2 reef. With the standard smelting process, there is a limit on the Cr<sub>2</sub>O<sub>3</sub> content of the concentrate to smelt, and this translates into a loss of PGE recovery during flotation, to meet the specifications.

While efforts are underway to improve PGE flotation recovery while achieving the chromite specification, modifications are also brought to the smelting process to allow higher chromite feeds. Some of these modifications are already being implemented, as described earlier (Jones, 1999; Cramer, 2001).

- Higher temperature smelting to maintain slag viscosity to an acceptable level, even at higher chromite content of the feeds.
- Slag cleaning to retreat the high chromite slag in a separate vessel so that most Cr<sub>2</sub>O<sub>3</sub> is not returned to the smelter.
- Mintek ConRoast process. Mintek has recently developed and patented a new smelting process that will allow treatment of high chromite feeds (Jones, 2001). The new process is shown in its simplified form in Figure 25.

Several advantages are cited for this process:

- All the SO<sub>2</sub> is captured during the dead roasting operation.
- The reductive smelting is not sensitive to the Cr<sub>2</sub>O<sub>3</sub> content of the feed.
- Iron is an excellent collector for PGE.
- A new leach process has also been developed to recover PGE, Ni and Cu from the Fe-PGE alloy.

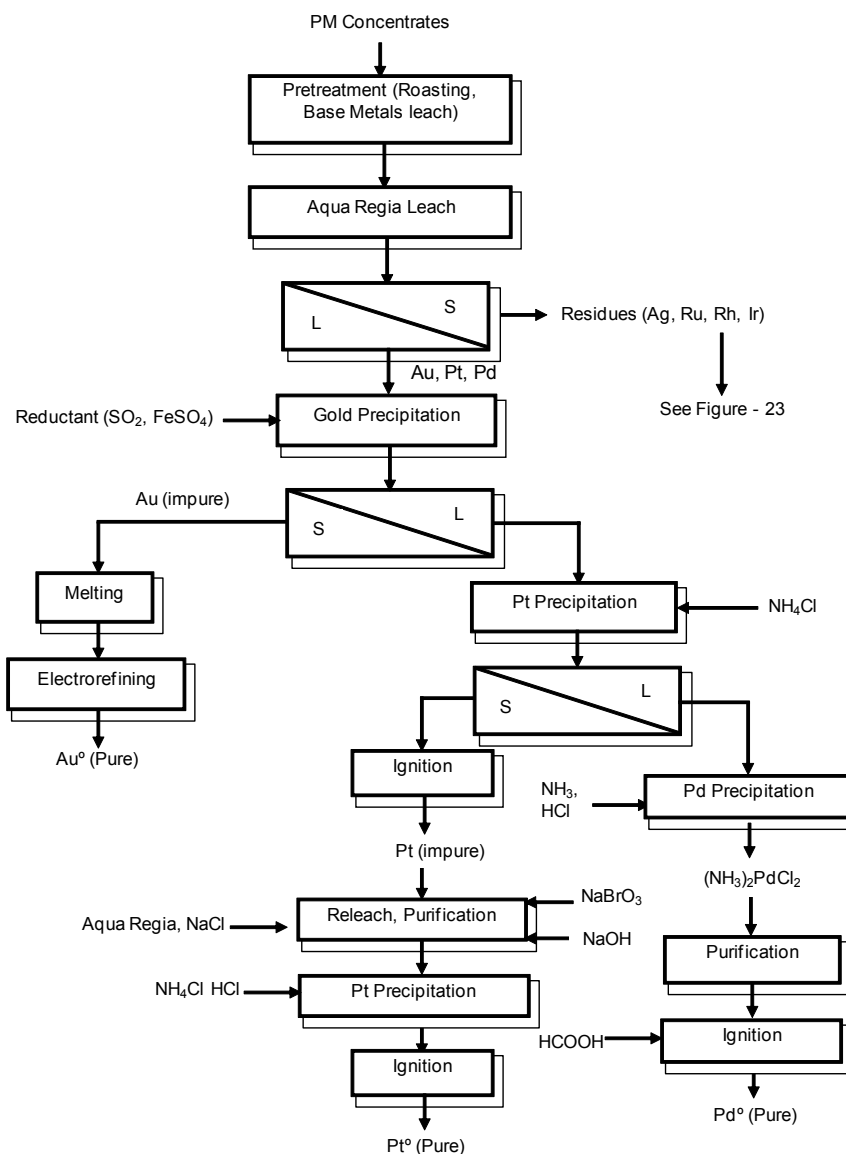

Figure 22. Classical Refining Process for Ag, Ir, Os, Ru, Rh - Inco Acton Refinery

Table 12. Commercial Solvent Extraction Systems for the Refining of Precious Metals (Demopoulos, 1989)

SOLVENT EXTRACTANTS	METALS EXTRACTED	INDUSTRIAL USERS	COMMENTS
(a) Compound Formation			
1. Alkyl sulphides (R <sub>2</sub> S)	Pd(III)	Inco	
Lonrho (?)	Slow kinetics		
High metal loading			
2. Phosphine sulphide (TIBPS)	Pd(II)	?	Pt/Pd separation based on differential kinetics
3. Hydroxyoximes	Pd(II)	MRR	Slow kinetics-low loading Use of accelerator
(b) Ion-pair formation			
1. Amines (Secondary; tertiary)	Pd(II), Pt(IV), Ir(IV)		
	MRR (Pt;Ir)		
PGP (?)	Selective stripping difficult Metal lock-up		
2. Ammonium salts	Pd(II), Pt(IV), Ir(IV), Rh(III)	?	Very difficult stripping
3. Tri butyl phosphate (TBP)	Pd(II), Pt(IV),		
Ir(IV)	Inco(Pt)		
Lonrho (Ir)			
Degussa (Pd,Pt,Ir)	Acid conc. and redox adjustment needed		
(c) Solvation			
1. Ketones (MIBK)	Au(III)	MRR	Reduction to metal with Fe <sup>0</sup> - Impure product
2. Ethers (DBC)	Au(III)	Inco	Reduction to metal with oxalic acid-very pure product

### Base Metals Refinery (BMR)

The original BMR at Lonrho Platinum in Marikana, South Africa has been described in the literature. Recent operating and flowsheet changes led to significant improvements (Steenkamp, Dunn, 1999).

In the original process, the converter matte was poured into moulds and allowed to cool down before being crushed. During this slow cooling, some sulphides oxidised to magnetite (FeO.Fe<sub>2</sub>O<sub>3</sub>) and trevorite (NiO.Fe<sub>2</sub>O<sub>3</sub>). These ferrites did not leach in the BMR leaching steps and reported to the PGE concentrate, diluting it. In the modified process, the converter slag is water granulated to reduce ferrite formation during cooling.

The original second stage pressure leach suffered from poor temperature control and excessive acidity, resulting in excessive PGE dissolution in the autoclave. The autoclave was re-designed to retain adequate control of sulphuric acid concentration and retention time while maintaining temperature control through the addition of cooling coils.

The effect of these changes on the quality of the PGE concentrate is illustrated in Table 13.

The modifications doubled the grade of the PGE concentrate and increased the amount of PGE, mostly rhodium, dissolved in the PGE refinery.

### Direct Leaching of PGE Ores/ Concentrates

#### Primary Sources

The present-day technology to treat high-grade PGE concentrates (smelting to matte, Base Metals Refinery) performs well and is well established. There are a few situations, however, where it is not suitable:

- The concentrate is too low grade or contains too many deleterious minerals for the smelter (i.e. Cr<sub>2</sub>O<sub>3</sub>, MgO, As, etc).
- The mine is remote and transportation costs to a centralised smelter would be prohibitive.
- Smelter contracts are not favourable to small operators.

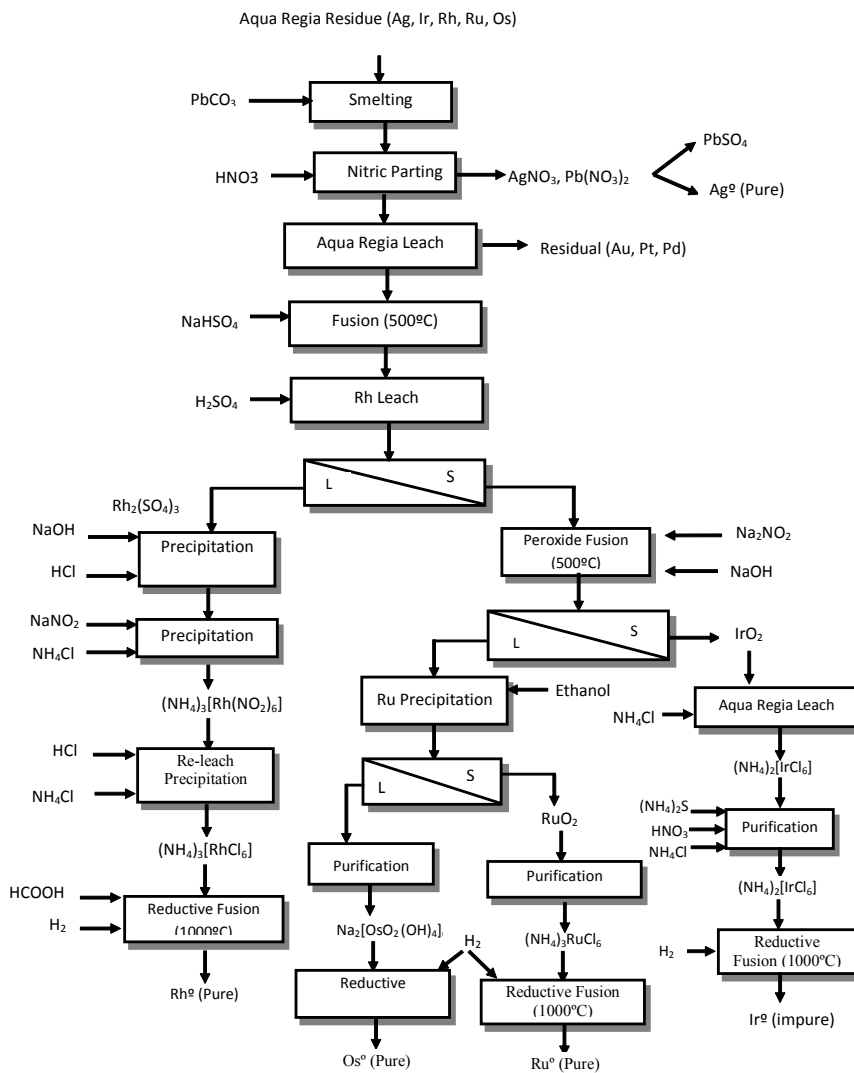

Figure 23. Modern Refining Process Scheme (Simplified) at Inco, Acton (UK)

Because of these potential issues, much effort has been devoted to develop alternative process routes. Since hydrometallurgical plants are best suited for small operations, this is the direction usually taken by the organisations searching for alternative processes. A few of these emerging new technologies will be described in the following pages.

**The BHP TML Process**

This process was developed to recover PGE from the oxidised portion of the Hartley deposit in Zimbabwe (Duyvesteyn et al., 1994).

A simplified flow chart diagram of the TML process is presented in Figure 26.

The following were the recommended process parameters:

- Roasting: 300-700°C, 60-90 minutes,

with air

- Leaching: 70°C, 2 hours, 100 g/L H<sub>2</sub>SO<sub>4</sub>,
- 10 g/L NaBr (>800 mV ORP using Br<sub>2</sub> (Geobrom 3400) as oxidant)
- 24-40% solids

Under those conditions, recoveries were 90% Au, 85% Pt and 70% Rh.

**The North American Palladium Process**

This process was developed at Lakefield Research in the early 1990's (McDoulett, Reschke, 1994) for the treatment of the Lac des Isles PGE concentrate assaying 4-6 g/t Au, 4-6 g/t Pt, 50-80 g/t Pd, 2.5-3.0% Cu, 1.8 - 2.5% Ni, 12-12.5% Fe and 6-8% S.

The patented process is illustrated in Figure 27.

The process consisted of:

- partial oxidizing roast of the concentrate
- pressure leaching (HCl/HNO<sub>3</sub>) of calcine
- filtration - washing
- activated C recovery of gold + PGE

Under those conditions, recoveries were 95-98% Au, 94-95% Pt, 87-91% Pd, 78-96% Cu, 82-92% Ni.

**High Temperature Cyanidation Process for the Coronation Hill Ore**

The Coronation Hill (Australia) deposit contains 3.5 M tonnes of ore assaying 5.1 g/t Au, 0.2 g/t Pt and 0.56 g/t Pd. Since the ore could not be upgraded by flotation nor gravity, a cyanidation process was developed by CSIRO. Several options were examined, with the best results obtained using the process illustrated in Figure 28 (Bruckard et al., 1992).

The process eventually recommended included:

- grinding - amalgamation
- high temperature (100-125°C) cyanidation, followed by (Au + Pt) CIP

Table 13. Effect of Process Modifications on PGE Concentrate Grade and Solubility

	PGE Conc. Grade (%)	% Dissolution in the Refinery		
		PGE	Pt	Rh
Original circuit	30	97	99.0	90.0
Modified circuit	60	99	99.7	99.0

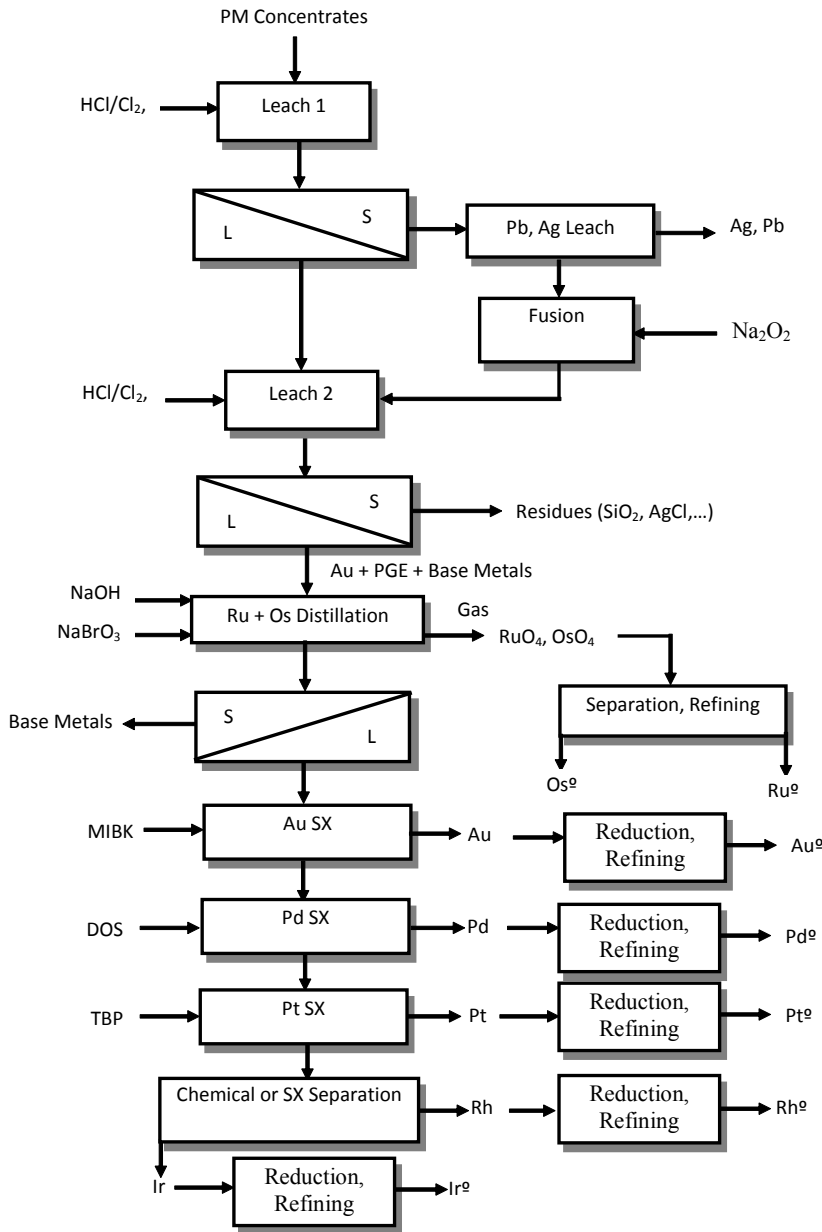

Figure 24. Mintek ConRoast Process to Treat High Cr<sub>2</sub>O<sub>3</sub> - PGE concentrates

PGE's are then recovered from solution using NaSH, while Cu, Ni, and Co are recovered using conventional techniques. The process flowsheet for the NorthMet concentrate is presented in Figure 29. Results of a 10-day integrated mini-pilot plant are summarised in Table 14.

The process has also been applied successfully to numerous other PGE/Cu-Ni concentrates, as well as to Cu-Au concentrates, Cu-Ni-PGE matte and Pt-laterites (Ferron et al., 2000a; Ferron et al., 2000b; Ferron, Fleming, 2001).

**Recycled Products: Auto Catalysts USBM Process**

In the early 1990's, the USBM developed a process capable of recovering PGE from autocatalysts (Atkinson et al., 1992; Kuczynski et al., 1992). A simplified flow diagram of the USBM process is presented in Figure 30.

More than 95% of the PGE were recovered in two successive leaches of the virgin monolithic catalysts, and more than 90% from used pellet catalysts. Recovery dropped to 85-90% PGE on used monolithic catalyst after three successive leaches.

**South Dakota School of Mines Process**

Researchers at the South Dakota School of Mines have been working for years on developing processes to recover PGE from various products (including auto catalysts) using ammonia and/or halogen salts, or halogen salts and sulphuric acids and/or ammonium salts as key solvents (Han, Meng, 1996).

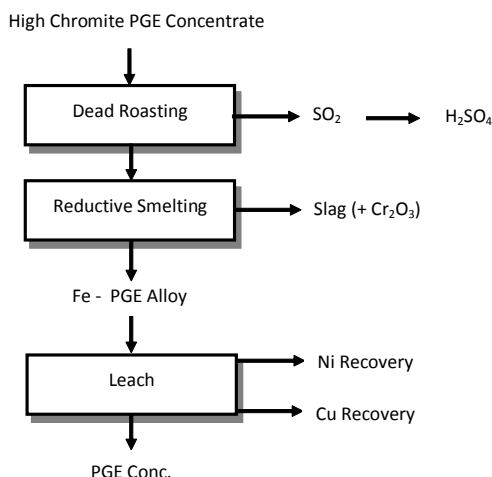

Figure 25. Simplified TLM Process Diagram for the Hartley Oxide Ore

Under those conditions, extractions were >95% Au, 90% Pd and 80% Pt. 4.2.1.4.

**The PLATSOL™ Process**

The PLATSOL™ process was developed at SGS in the late 1990's by International PGE Technologies to treat PolyMet NorthMet (formerly Dunka Road) deposit within the Duluth Gabbro in Minnesota, USA (Fleming et al., 2000; Ferron et al., 2000; Ferron et al., 2001). It is a high temperature (>200°C) pressure oxidation sulphate-based process with small additions of NaCl (5-20 g/L NaCl). Under those conditions, the base metals (Cu, Ni, Co) and the precious metals (Au, Pt, Pd) are dissolved in one single step. The

At 200°C, with 87 psi oxygen over-pressure and using sulphuric acid, ammonium iodide and ammonium bromide, 98% of the Pt, 92% of the Pd and 97% of the Rh were extracted in one hour.

**McGill University Process**

The process developed by McGill researchers involved the percolation leaching of uncrushed pellets or 5-10 cm crushed monolithic catalyst, using an upward flow of a 85-95°C aluminium chloride/hydrochloric acid/nitric acid leach mixture. Ninety-eight percent of the PGE's were recovered in 90 minutes leach time.

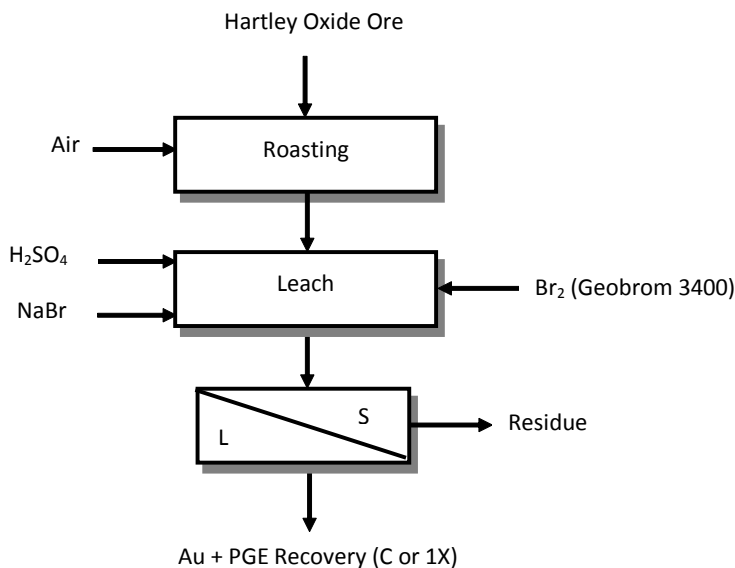

Figure 26. Process Flowsheet for the Treatment of the Lac des Iles PGE Concentrate

Table 14. Pilot Plant Results - PLATSOL™ Treatment of the NorthMet Concentrate

	FEED	STEADY-STATE	
		RESIDUE	EXTRACTION %
Cu (%)	14.7	0.074	99.6
Ni (%)	3.05	0.047	98.9
Co (%)	0.14	0.006	96.0
Fe (%)	32.9	44.07	
Pd (g/t)	9.90	0.72	94.6
Pt (g/t)	2.22	0.12	96.0
Au (g/t)	1.41	0.20	89.4

The aluminium oxide dissolved from the substrate was recovered as alumina Al<sub>2</sub>O<sub>3</sub> or alum Al<sub>2</sub>(SO<sub>4</sub>)<sub>3</sub>.nH<sub>2</sub>O (Letowski, Distin, 1989).

**The Amax Process**

In 1981, Amax developed a process to recover PGE's from spent catalysts (Bonucci, Parker, 1984). The process is illustrated in Figure 31.

The process recommended comprised:

- calcination at 1500°C
- PGE leaching (HCl/HNO<sub>3</sub>), followed by filtration/washing
- lead precipitation from leach solution using H<sub>2</sub>SO<sub>4</sub>
- H<sub>2</sub>S precipitation of PGE's
- recycle of leach solution
- treatment of a bleed to precipitate aluminium

The calcination step was required to transform the soluble -alumina into insoluble -alumina, thereby decreasing

acid consumption by recycling a large portion of the leach solution. The calcination step is not needed for monolithic catalysts.

**The Platinum Lake CRO - Redox Process**

The process, developed at Ontario Research Foundation (now Ortech) is illustrated in Figure 32 (Lakshmanan, Ryder, 1988; Lakshmanan et al., 1989).

The CRO process included:

- calcination at 100°C for one hour
- reduction pretreatment
- chloride leaching in the presence of a proprietary additive (Borohydride)
- liquid/solid separation to remove lead salts
- solvent extraction (Oxime - Kelex 100) of both Pt, Pd followed by selective stripping
- precipitation (cementation) of Pt and Pd

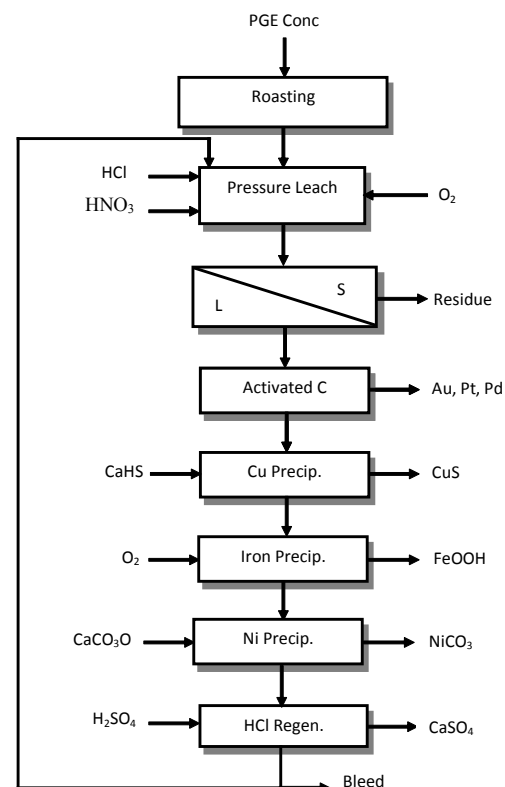

Figure 27. Process Flowsheet for the Treatment of the Lac des Iles PGE Concentrate

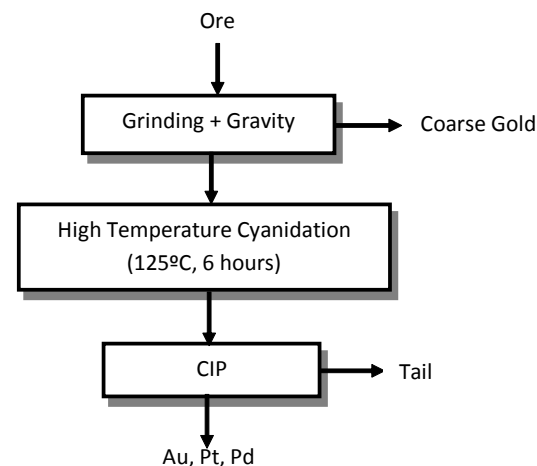

Figure 28. Process Flowsheet for the PLATSOL™ Treatment of NorthMet Concentrate

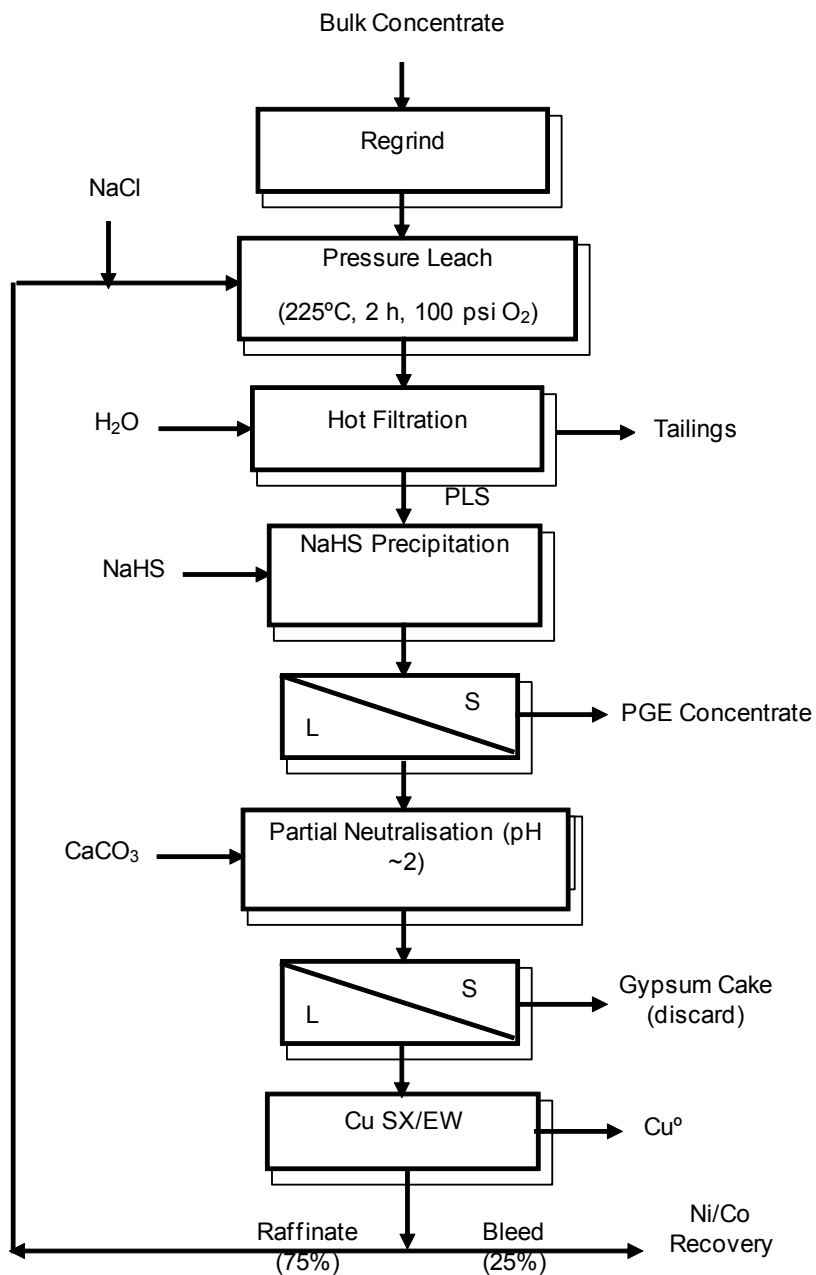

Figure 29. Simplified Flow Chart Diagram of the USBM Process

Leaching recoveries were >93% for Pt and >98% for Pd.

**The PLATSOL™ Process**

The PLATSOL™ process has been described earlier. It was also tested on various auto catalysts (Ferron et al., 2001a).

Good extractions are obtained as per results presented in Table 15.

**Refining of PGE Concentrates  
Solvent Extraction**

The success of solvent extraction as applied in some of the largest PGE

refineries has resulted in a flurry of research into finding alternative reagents for the selective extraction of the PGE. Table 16 presents a non-exhaustive list of extractants tested for the recovery of PGE.

The most elusive area appears still to be the development of a commercial SX process for the recovery of rhodium (Benguerel et al., 1996; Nicol, 2000). Typically, the iridium and rhodium are recovered after all the other PGE have been recovered because of the difficulties of the separation and the lower concentrations of these two

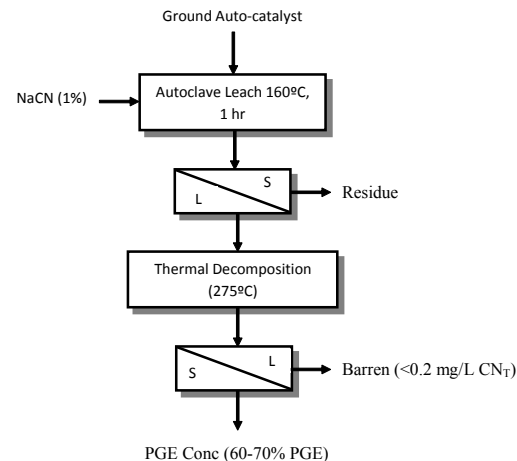

Figure 30. Flowsheet for the Treatment of Spent Catalysts. The Amax Process

metals compared to the major PGE (Pt, Pd). A commercial process conditions the Ir-Rh chloride solution by adjusting its chloride content and oxidising the iridium to the Ir (IV) stage before extracting it using a solvating extractant (TBP or N-substituted monoamide). The efficiency of the separation is based on the fact that rhodium can only form hexachlorocomplexes in very concentrated chloride solutions; in addition, the order of extraction of chlorocomplexes depends strongly on the charge of the complex, with doubly charged anions ( $\text{IrCl}_6^{2-}$ ) being extracted more strongly than triply charged anions ( $\text{RhCl}_6^{3-}$ ).

Recent work has indicated that the solvent extraction of rhodium from chloride solutions is greatly improved with the addition of  $\text{SnCl}_2$  (Mhaske et al., 2001; Shafiqul et al., 1997).

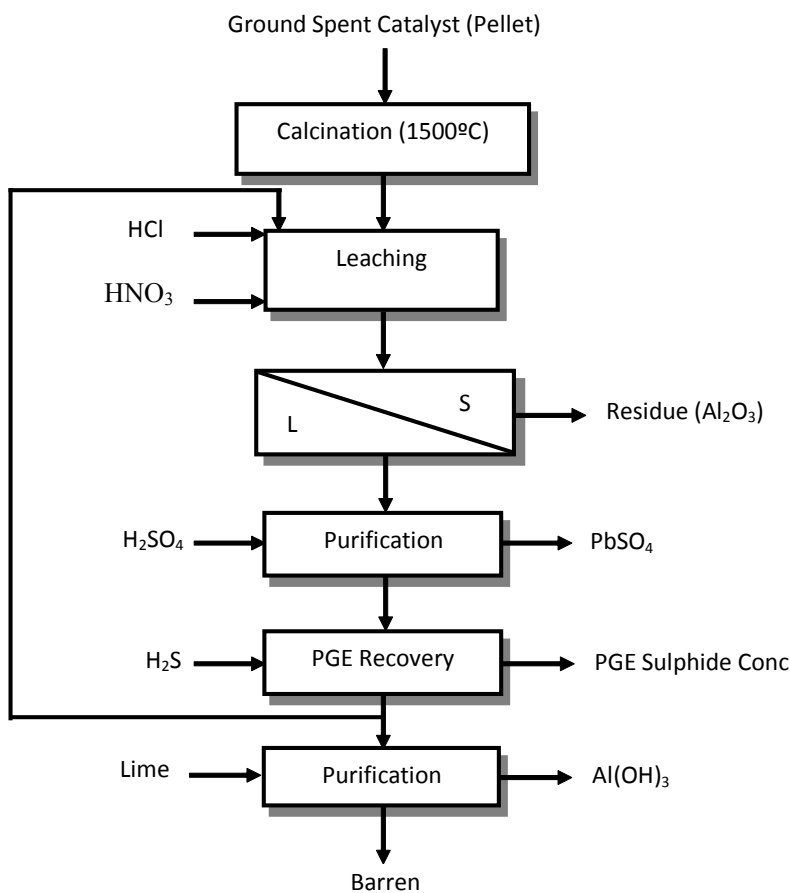

Figure 31. Platinum Lake Process Flowsheet

**Ion Exchange Resins**

Several ion exchange resins have been developed and tested for application in the PGE industry.

- Polyisothioureia (PITU) (Warshawsky, 1983). These chelating resins are not selective; they serve to extract all PGE selectively vs. the base metals. The elutant is thiourea, and the PGE can then be separated by precipitation or solvent extraction.
- Amborane Resins (Rohm, Haas) (Demopoulos, 1989). They are mildly reducing agents (amine-boranes), reacting with the precious metals to produce boric acid and metallic precious metal covering the polymer bead. It is unfortunately not selective and it has to be burned to recover the precious metals on it.
- SuperLig (IBC Advanced Technologies) (Ruckman, 1989): These are molecular recognition ligands (MRT) that are engineered in such a manner as to allow only ions of the correct size to fit into their active sites. Different

SuperLig reagents have been developed for various duties.

Two commercial PGE operations are known to have introduced MRT systems in their refinery.

Tanaka Kikinzoku Kogyo (TKK) precious metal refinery near Tokyo recovers rhodium from the refinery feedstream containing PGE and base metals, using five columns in series of SuperLig 96. Starting from 17 g/L Rh, 98% of the Rh is recovered in one pass. The Rh eluate

is then polished with SuperLig 133 to produce a 99.95% minimum Rh purity.

In 1997, Impala installed a MRT system for the separation and purification of Pd in their primary PGE refinery (Robinson, 1995; Van Tonder et al., 2001). The installed system is comprised of 16 columns each with 32 kg of SuperLig. The process is shown in Figure 33.

Typical purities of 99.98-99.99% Pd are achieved. With the introduction of the MRT system, overall Pd recoveries have been improved while shortening the overall process route.

- Resin TP-207 (Bayer). It is a selective resin, normally sold as a sodium salt of the iminodiacetic acid functional group. The resin has been piloted by Noranda to recover Pd from Moebius cell electrolyte (Rosato, Shink, 1989). During silver electrorefining, Pd and Cu dissolve and accumulate in the nitrate electrolyte, and a bleed is required to control the build-up of these elements and maintain silver purity. Starting from electrolytes assaying 150-200 g/L Ag, 100 mg/L Pd and 15-25 g/L Cu, using the TP 207 resin, palladium was reduced to less than 5 mg/L. Eluting the loaded resin with 50-100 g/L HNO<sub>3</sub> removed co-adsorbed copper; the Pd was then stripped using 100-150 g/L HCl.

Table 15. PLATSOL™ Results on Various Auto Catalysts

ELEMENT	VIRGIN		USED				
	(MONOLITHIC)		(MONOLITHIC)		(PELLET)		
	g/t Feed	% Rec	g/t Feed	% Rec (1)	g/t Feed	% Rec (1)	% Rec (2)
Pt	663	97.1	998	84.9	335	72.1	93.7
Pd	470	98.6	-	-	141	86.0	95.2
Rh	-	-	44.7	66.1	-	-	-

Table 16. Some of the Chemistry Tested for PGE SX

EXTRACTANT	APPLICATION	REFERENCE
1. 8-Hydroxyquinoline derivative (8-HQ) - Kelex 100, LIX 26 - TN 1911 - Kelex 100	Pd(II) + Pt(IV), Selective stripping Pd(II) + Pt(IV), Selective stripping Rh	Demopoulos, 1989 Demopoulos, et al., 1989 Yan, et al., 1994
2. Pyridine Carboxylic Esters - Acorga CLX-50	Pd(II)	Burgess, et al., 1990 Dalton, et al., 1993
3. Hydroxyoximes - P50	Pd(II)	Jackson, 1992
4. Oxime - MOC-15 (Allied Signal)	Pd(II)	Dimmit et al, 1989
5. Octylamine pyridine (OAP)	Rh	Petrukhin et al., 1980
6. Trioctylamine (TOA)	All PGE selectively from base metals in nitrite solution	Kuzmichev, et al.
7. Phenylbenzamidines	Pd(II)	Antico, et al, 1994
8. Benzoyl Thiourea	Pd(II)	Antico, et al, 1994

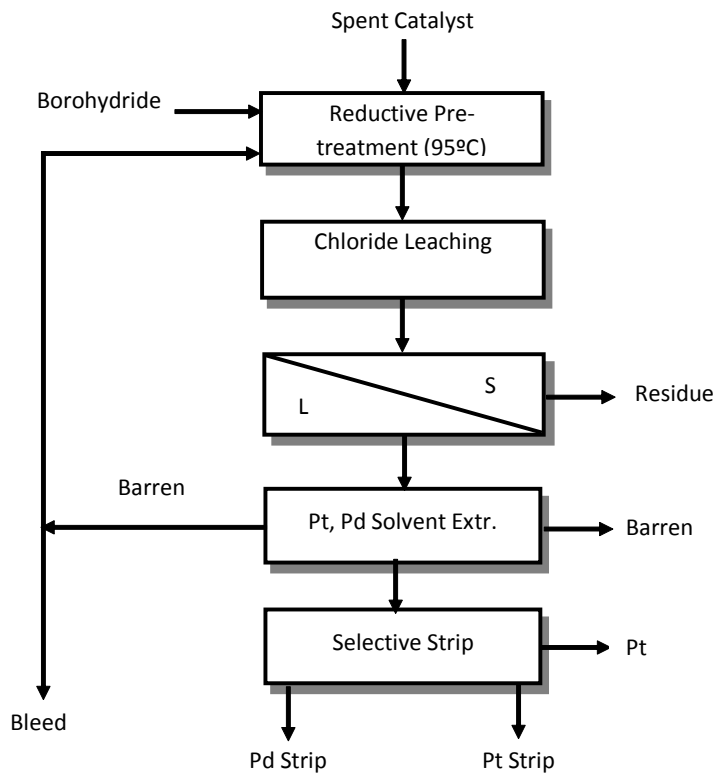

Figure 32. Platinum Lake Process Flowsheet



## CLOSING COMMENTS

The preparation of a review to cover the beneficiation and extractive metallurgy of the platinum group elements is not an easy task, for several reasons.

There are six elements in the group (usually plus gold), and are usually found associated with each other. Their chemical properties are sufficiently close to make their separation difficult.

Because of their high value, they are recovered from low-grade resources (a few grams per tonne) and from a large variety of host minerals. Due to their low concentration in the process feeds, fairly elaborate techniques have to be used to measure their chemical and mineralogical properties.

Although the situation has significantly improved over the last few years, published information is rather limited when compared to other metals. This is due to the very competitive nature of that business segment on one hand, and to geopolitical events on the other hand, that resulted in decades of complete blackout of technical information from the former U.S.S.R., one of the very large PGE producers.

Because more than 90% of the world PGE originate from only two countries, there was a temptation to concentrate only on the information released from Russia and South Africa, and not paying enough attention to the wealth of good technical data originating from other sources. The authors have attempted to incorporate in this review the published information available to them from sources throughout the world, irrespective of the size of the operation, even to include operations not longer in existence.

## ACKNOWLEDGEMENTS

The authors are grateful to the several reviewers who, with their corrections, comments and suggestions, significantly contributed to improve the quality of this review. Included were: James Hoffmann (J. Hoffmann and Associates), Prof. Tai Yen (Queen's University), Dee Bradshaw, Peter Gaylard and Martin Wright, (University of Capetown), and Chris Fleming, (SGS).

## REFERENCES

1. ALAPIETI, T.T., LAHTINEN, J., 2002. Platinum-group element mineralization in layered intrusions of northern Finland and the Kola Peninsula, Russia. In the *Geology, Geochemistry, Mineralogy and Mineral Beneficiation of Platinum-Group Elements*, Edited by L.J. Cabri. Canadian Institute of Mining, Metallurgy, and Petroleum, this volume, p. 507-546.
2. ALDRICH, C., MOOLMAN, D. W., BUNKELL, S. J., HARRIS, M. C., THERON, D. A., 1997. Relationship between surface Froth Features and Process Conditions in the Batch Flotation of a Sulphide Ore. *Minerals Engineering*, Volum 10, No. 11, pp. 1207-1218.
3. ALEKSEEVA, L.I., YATSENKO, A.A., BASKAYEV, P.M., ZAKHAROV, B.A., ISMAGILOV, R.I.. Combined Methods and New Reagents in Processing of Disseminated Ores are the Basis of Increase in Nonferrous and Precious Metals Recovery; Unknown.
4. ANON, 1979. New UK Precious Metals Refinery. *Mining Magazine*, December, p. 570-576.
5. ANTICO, E., MASANA, A., HIDALGO, M., SALVADO, V., VALIENTE, M., 1994. New Sulphur-Containing Reagents as Carriers for the Separation of Palladium by Solid Supported Liquid Membranes. *Hydrometallurgy* 35, pp. 343-352.
6. ATKINSON, G.B., KUCZYNSKI, R.J., DESMOND, D.P., 1992. Cyanide Leaching Method for Recovering Platinum Group Metals from a Catalytic Converter Catalyst. US Patent, 5,160,711, November.
7. AUGÉ, T, CABRI, L.J., LEGENDRE, O., McMAHON, G and COCHERIE, A., 1999. PGE distribution in base-metal alloys and sulfides of the New Caledonia Ophiolite, *Canadian Mineralogist*, 37, p. 1147-1161
8. BARNES, J.E., EDWARDS, J.D., 1982. Solvent Extraction at Inco's Precious Metal Refinery. *Chemistry and Industry*, March, pp. 151-155.
9. BARRIE, C.T., MacTAVISH, A.D., WALFORD, P.C., CHATAWAY, R. and MIDDGAUGH, R., 2002. Contact type and magnetite reef-type PD-Cu mineralization in ferrian olvine gabbros of the Coldwell Complex, Ontario. In *The Geology, Geochemistry, Mineralogy and Mineral Beneficiation of Platinum-Group Elements*. Edited by L.J. Cabri. Canadian Institute of Mining, Metallurgy, and Petroleum, this volume, p. 321-337.
10. BEKE, G., 2001. Recycling Precious Metals from E-Scrap: A Challenging Future. IPMI 25th Annual Conference, Tucson, June.
11. BENGUEREL, E., DEMOPOULOS, G.P., HARRIS, G.B., 1996. Speciation and Separation of Rhodium (III) from Chloride Solutions: A Critical Review. *Hydrometallurgy* 40, pp. 135-152.
12. BILODEAU, A., HARRIS, G.B., HOOPER, K., MACDONALD, C.A., STANLEY, R.W., 1987. Silver Refinery Anode Slimes Treatment at the CCR Division of Noranda Inc. *The Electrorefining and Winning of Copper*. TMS, Denver, pp 527-545.
13. BLAGODATIN, Y.V., DISTLER, V.V., ZAKHAROV, B.A., SLUZHENIKIN, S.F., 2000. Disseminated Ores of the Noril'sk Ore District as a Potential for Increasing output of Platinum Metals at the Noril'sk Mining Company; *Ore Base 2000*. Special Issue.
14. BONUCCI, J.A., PARKER, P.D., 1984. Recovery of PGM from Automobile Catalytic Converters. *Precious Metals: Mining, Extraction and Processing AIME/TMS*, Los Angeles 1984, pp. 463-481.
15. BRUCKARD, W.J., McDONALD, K.J., McINNES, C.M., SPARROW, G.J., WOODCOCK, J.T., 1992. Platinum, Palladium, and Gold Extraction from Coronation Hill Ore by Cyanidation at Elevated Temperature. *Hydrometallurgy*, 30 (1992). pp211-227.
16. BRUGMAN, C.F., KERFOOT, D.G., 1986. Treatment of Nickel-Copper Matte at Western Platinum by the Sherritt Acid Leach Process. *CIM 25th Annual Conference of Metallurgists*. pp. 512-531.
17. BURGESS, A., DALTON, R.F., 1990. Solvent Extraction of Palladium by Pyridine Carboxylic Esters. *Solvent Extraction*, T. Sekine (Editor) Elsevier, pp. 1087-1092.
18. CABRI, L.J., 1981. Platinum-Group Elements: Mineralogy, Geology, Recovery. *CIM Special Volume 23*.
19. CABRI, L.J., 1992. The distribution of trace precious metals in minerals products. The 23rd Hallimond Lecture (1991). *Mineralogical magazine*, 56, p. 298-308.
20. CABRI, L.J., LAFLAMME, J.H.G., 1981. Sample preparation methods for platinum-group element-bearing materials. In *Platinum-Group Elements: Mineralogy, Geology, Recovery*. Edited by L.J. Cabri. Canadian Institute of Mining, Metallurgy and Petroleum, Special Volume 23, p. 65-70.
21. CHADWICK, J., 1996. Hartley platinum, *Mining Magazine*, Sept, pp. 131-144.
22. CHAMBER OF MINES OF SOUTH AFRICA, 2001. Platinum Group Metals in South Africa; [www.bullion.org.za](http://www.bullion.org.za);
23. CLEARE, M.J., CHARLESWORTH, P., BRYSON, D.J., 1979. Solvent Extraction in Platinum Group Metal Processing. *J. Chem. Tech. Biotechnol.*, pp. 210-224.
24. CLEARE, M.J., GRANT, R.A., CHARLESWORTH, P., 1981. Separation of the Platinum Group Metals by use of Selective Solvent Extraction Techniques. *IMM Extraction Metallurgy 1981*, pp 34-41.
25. CRAMER, L.A., 2001. The Extractive Metallurgy of South Africa's Platinum Ores. *JOM*, October. pp 14-18.
26. CURRY, D, 2001. PGM Fine Grinding; Technology, Trends and Applications. *SAIMM Colloquium - Developments in Metallurgical Processing in the Platinum Industry*, Rustenburg, November.
27. DALTON, R.F BURGESS, A., TOWNSON, B., 1993. Solvent Extraction of Palladium from Nitrate Solution by Novel Reagents Based on Pyridine Carboxylic Esters. *ISEC 93*, York (UK), Logsdall-Slater (Editors).
28. DEMOPOULOS, G.P., 1986. Solvent Extraction in Precious Metals Refining, *JOM*, June. pp 13-17.
29. DEMOPOULOS, G.P., 1989. Refining of platinum-group metals, *CIM Bulletin*, March, pp. 165-171.

30. DEMOPOULOS, G.P., KUYUCAK N., GEFVERT, D.L. 1989. TN 1911: A New Hydroxyquinoline Extractant for the Refining of Platinum Metals. *Precious Metals 1989*, IPMI, B. Harris Ed., pp. 201-215.
31. DIMMIT, J.H., COLBY, S.J., 1989. Solvent Extraction of Pd(II) with MOC-15 Extractant. *Precious Metals 1989*, IPMI, B. Harris Ed., pp. 229-236.
32. DISTLER, V.V., SLUZHENIKIN, S.F., CABRI, L.J., KRIVOLUTSKAYA, N.A., TUROVTSEV, D.M., and OLESHKEVICH, O.I., 1999. PGE-bearing ores of the Noril'sk layered intrusions; Relationship between magmatic and fluid concentrations of noble metals. *Geology of Ore Deposits*, 41 p. 241-265 (in Russian), and p. 214-237 (in English with slightly different title).
33. DUYVESTEYN, S, HOUYUAN, L., DUYVESTEYN, W.P.C., 1994. Recovery of Platinum Group Metals from Oxide Ores -The TML Process. *Hydrometallurgy 94*, IMM/SCI Chapman and Hall, pp. 887-912.
34. DYAS, K., MARCUS, J., 1998. Stillwater Plans to Triple PGM Production by 2003. *EMJ*, December, pp. 20-25.
35. EDWARDS, R.I., 1977. Selective Solvent Extractants for the Refining of Platinum Metals. *CIM Special Volume 21*, ISEC 77, pp. 24-31.
36. EDWARDS, R.I., 1976. Refining of the platinum-group metals, *JOM*, Vol. 28.
37. ERMAKOV, A.V., BOGDANOV, V.I., GORBATOVA, L.D., KONIK, K.P., 2000. On the Possibility of Electrochemical Separation of Precious Metals During Process of Heavily Contaminated Starting Material of Iridium. *Ohriner, Lanam, Panfilov, Harada Ed.*, pp. 415-420.
38. FARROW, C.E.G. and LIGHTFOOT, P.C., 2002. Sudbury PGE revisited: Toward an integrated model. In *The Geology, Geochemistry, Mineralogy and Mineral Beneficiation of Platinum-Group Elements*. Edited by L.J. Cabri. Canadian Institute of Mining, Metallurgy and Petroleum, this volume, p. 237-297.
39. FERRON, C.J., FLEMING, C.A., DREISINGER, D.B., O'KANE, P.T., 2000. Application of the PLATSOL™ Process to Copper-Gold Concentrates. *Randol Copper*, Tucson.
40. FERRON, C.J., FLEMING, C.A., DREISINGER, D.B., O'KANE, P.T., 2000. One-Step Leaching of Gold, PGM's and Base Metals from Various Ores and Concentrates. *Randol Gold*, Vancouver.
41. FERRON, C.J., FLEMING, C.A., DREISINGER, D.B., O'KANE, P.T., 2001. Application of the PLATSOL™ Process for the Simultaneous Dissolution of Copper, Nickel, Gold and PGM's from Sulphide Concentrates and Autocatalysts, IPMI 25th Annual Conference, Tucson, June.
42. FERRON, C.J., FLEMING, C.A., DREISINGER, D.B., O'KANE, P.T., 2001. PLATSOL™ Treatment of the NorthMet Copper-Nickel - PGM Bulk Concentrate - Pilot Plant Results. *ALTA 2001*, Perth, Australia.
43. FERRON, C.J., FLEMING, C.A., 2001. The PLATSOL™ Process - Does it have a Place in the South African Platinum Industry? *SAIMM Colloquium - Developments in Metallurgical Processing in the Platinum Industry*, Rustenburg, November.
44. FERRON, C.J., FLEMING, C.A., DREISINGER, D.B., O'KANE, P.T., 2000. Single-step Pressure Leaching of Base and Precious Metals (gold and PGM'S's) using the PLATSOL™ Process.
45. FLEMING, C.A., FERRON, C.J., DREISINGER, D.B., O'KANE, P.T., 2000. A process for the simultaneous leaching and recovery of gold, platinum group metals and base metals from ores and concentrate, *EPD Proceedings, TMS Annual Meeting*, Nashville, March, pp 419-431.
46. FOO, G. 1982. A Critical Analysis of the Processing Parameters in Palladium Refining. *Precious Metals*. IPMI, pp. 463-475.
47. FRUH, E, 1986. Personal Communication, May.
48. FUGLEBERG, S. HULTHOLM, S.E., ROSENBACK, L., HOLOHAN, T., 1995. Development of the Hartley Platinum Leaching Process. *Hydrometallurgy 39*, pp. 1-10.
49. GOODALL, C. M., KNOPJES, H. G., DE BEER, F., STEYN, J. J., 2001. The Reduction of the PGM values in Eastern Platinum Cleaner Tailings - A Case Study. *Mine Managers' Association Circular #1 2001*.
50. HAGELÜKEN, C., 2001. Serving the PGM Life Cycle -The New Alignment of the dmC2 Refinery at Hanau, Germany. *IPMI 25th Annual Conference*, Tucson, June.
51. HAN, K.N., MENG, X., 1996. Recovery of Platinum Group Metals and Rhenium from Materials using Halogen Reagents., *US Patent 5,542,957*, August.
52. HILLIARD, H.E., 2000. *Platinum Group Metals, Platinum Group Metals 2000*, pp. 59.1-59.7.
53. HOCHREITER, R.C., KENNEDY, D.C., MUIR, W., WOOD, A.I. 1985. Platinum in South Africa, *Journal of the South African Institute of Mining and Metallurgy*, June, pp.165-185.
54. HODGES, G.J., ROSET, G.K., MATOUSEK, J.W., MARCANTONIO, P.J., 1991. Stillwater Mining Co.'s Precious Metals Smelter: from Pilot to Production. *Mining Engineering*, July, pp 724-727.
55. HODGES, G.J., CLIFFORD, R.K., 1988. Recovering Platinum and Palladium at Stillwater; *Journal of Metals*, pp. 32 – 35, June.
56. HOFFMANN, J.E., 1988. Recovering Platinum - Group Metals from Auto Catalysts. *JOM*, June, pp 40-44.
57. HOFFMANN, J.E., WESSTROM, B., 1994. Hydrometallurgical Processing of Refinery Slimes at Phelps Dodge: Theory to Practice. *Hydrometallurgy 94 IMM/SCI Chapman and Hall*, pp. 69-105.
58. HOFIREK, Z, HALTON, P., 1990. Production of High Quality Electrowon Nickel at Rustenburg Base Metals Refiners (PTY). Ltd. in: *Electrometallurgical Plant Practice*, Claessens, Harris (Ed), Pergamon Press, pp. 233-251.
59. HOFIREK, Z., KERFOOT, D.G.E., 1992. The Chemistry of the Nickel-Copper Matte Leach and its Application to Process Control and Optimisation. *Hydrometallurgy 29*, pp. 357-381.
60. HOUGEN, L.R., ZACHARIASEN, H., 1975. Recovery of Nickel, Copper and Precious Metal Concentrate from High Grade Precious Metal

- Mattes. JOM, May, pp. 6-9.
61. HYVÄRINEN O., ROSENBERG, E., LINDROOS, L., 1984. Selenium and Precious Metals Recovery from Copper Anode Slimes at Outokumpu Pori Refinery. *Precious Metals: Mining, Extraction and Processing* AIME/TMS, Los Angeles, pp. 537-548.
  62. IZATT, R.M., CLARK, G.A., CHRISTENSEN, J.J., 1987. Transport of AgBr<sub>2</sub><sup>-</sup>, PdBr<sub>4</sub><sup>2-</sup>, and AuBr<sub>4</sub><sup>-</sup> in an Emulsion Membrane System using K<sup>+</sup>- Dicyclohexano - 18 - Crown - 6 as Carrier. *Separation Science and Technology*, Vol. 22. pp. 691-699.
  63. JK World, 2001. Newsletter of the Julius Kruttschnitt Mineral Research Centre, Issue 8, December 2001.
  64. JACKSON, E., 1992. Solvent Extraction of Palladium from Aqueous Nitrate Solutions with P-50 Oxime and its Separation from Rhodium. *Chemistry and Industry*, October, pp. 783-784.
  65. JAMES, R.S., JOBIN-BEVANS, S. EASTON, M. WOOD, P HROMINCHUK, J.L., KEAYS, R.R. and PECK, D.C, 2002. Platinum-Group element mineralization in paleoproterozoic basic intrusions in central and northeastern Ontario, Canada. In *The Geology, Geochemistry, Mineralogy and Mineral Beneficiation of Platinum-Group Elements*. Edited by L.J. Cabri. Canadian Institute of Mining, Metallurgy and Petroleum, this volume, p. 339-365.
  66. JOHAN, Z/, 2002. Alaskan-type intrusive complexes and their PGE mineralization. In *The Geology, Geochemistry, Mineralogy and Mineral Beneficiation of Platinum-Group Elements*. Edited by L.J. Cabri. Canadian Institute of Mining, Metallurgy and Petroleum, this volume, p. 669-719.
  67. JOHNSON MATTHEY, 2001. *Platinum Today*; www.platinum.matthey.com.
  68. JONES, R.T., 1999. Platinum Smelting in South Africa. *South African Journal of Sciences*, 95, Nov/Dec, pp. 525-534.
  69. JONES, R.T., 2001. ConRoast - DC Arc Smelting of Dead-roasted Sulphide Concentrates. SAIMM Colloquium - Developments in Metallurgical Processing in the Platinum Industry Rustenburg, November.
  70. KERFOOT, D.G.E., 1986. Review of hydrometallurgical nickel refining operations: Responses to questionnaire. *Nickel Metallurgy*, Volume I, Extraction and Refining of Nickel, Ozberk, Marcusson, Eds., 25th Annual Conference of Metallurgists, CIM, March, pp. 426-441.
  71. KOLSTAD, J., NEWMAN, L., 1998. The BMR refinery at Stillwater, New Dimensions in Hydrometallurgy, FDW Seminar, Vancouver.
  72. KOZYREV, S.M., KOMAROVA, M.Z., EMELINA, L.N
  73. KRUGER, B, 2001. Smelter Upgrade at Impala, 1999-2000. SAIMM Colloquium - Developments in Metallurgical Processing in the Platinum Industry, Rustenburg, November.
  74. KUCZYNSKI, R.J., ATKINSON, G.B., WALTERS, L.A., 1992. High-temperature Cyanide Leaching of Platinum-Group Metals from Automobile Catalysts - Process Development Unit. US Bureau of Mines Investigations No. 9428.
  75. KUZMICHEV, G.V., BLEDNOV, V.P., DULNEVA, V.E. Using Trioctylamine to Extract Platinum Metals from Nitrite Solutions, *Tvetsnye Metally*, pp. 63-64.
  76. LAKSHMANAN, V.I., TODD, I.A., RYDER, J., ZAMORA, M.J., 1989. Recovery of Platinum and Palladium from Spent Automotive Catalysts. IPMI, pp. 237-242.
  77. LAKSHMANAN, V.I., RYDER, J., 1988. Recovery of Precious Metals from Spent Automotive Catalysts. AIME Meeting, Tucson.
  78. LAWRENCE, S.R., 2001. Aspects of DMS plant design, South African Institute of Mining and Metallurgy Colloquium - Developments in Metallurgical Processing in the Platinum Industry.
  79. LESSARD, B., 1989. Anode Slimes Treatment in a Top Blown Rotary Converter at the CCR Division of Noranda Minerals Inc. *Precious Metals 1989*, IPMI, B. Harris Ed., pp. 427-440.
  80. LETOWSKI, F, DISTIN, P.A., 1989. Development of Aluminum Chloride Leach Process for Platinum and Palladium Recovery from Scrapped Automotive Catalysts. *Precious Metals 1989*, IPMI, B. Harris Ed., pp. 41-49.
  81. LIKHACHEV, A.P., 1999. Characteristics of the distribution and concentration of platinum metals and other ore components in Talnakh intrusions. In *Platinum of Russia, Volume IV - Problems of Development of the Platinum metals Resource Base in the XXI Century (mineralogy, genesis, technology)*. Geoinformmark, Moscow, p. 86-100 (in Russian).
  82. MANZONE, M.G., OPIE, W.R., 1977. Recycling Copper Scrap at United States Metals Refining Company. CIM, August.
  83. McDOULETT, C. D., RESCHKE, G. W., 1994. Metal Leaching and Recovery Process. U.S. Patent, 5,364,444.
  84. MERKLE, R.K.W. and MCKENZIE, A.D., 1994. The mining and beneficiation of South African PGE ores - an overview. In *The Geology, Geochemistry, Mineralogy and Mineral beneficiation of Platinum-Group Elements*. Edited by L.J. Cabri. Canadian Institute of Mining, Metallurgy and Petroleum, this volume, p. 793-809.
  85. MHASKE, A.A., DHADKE, P.M., 2001. Extraction Separation Studies of Rh, Pt and Pd using Cyanex 921 in Toluene - A Possible Application to Recovery from Spent Catalysts. *Hydrometallurgy*, 61, pp. 143-150.
  86. MISHRA, R.K., 1988. Recovery of Platinum Group Metals from Automobile Catalytic Converters- A Review. *Precious Metals 89*, Jha, Dill (Ed), TMS, pp 483-501.
  87. MITKIN, V.N., 2000. Fluorination of Iridium Metal and its Application Possibilities in the Synthesis, Analysis and Recovery Technology for Secondary Raw Materials (Review) in *Iridium*. Ohriner, Lanam, Panfilov, Harada Ed, pp. 361-376.
  88. MOOLMAN, d. w., ALDRICH, C., SCHMITZ, G. P. J., VAN DEVENTER, J. S. J., 1996. The Interrelationship between surface froth Characteristics and Industrial Flotation Performance., *Minerals Engineering*, Volume 9, No. 8, pp.

- 837-854.
89. MORRISON, B.H., 1985 Recovery of Silver and Gold From Refinery Slimes at Canadian Copper Refiners. IMM Extractive Metallurgy, pp. 249-269.
90. MORRISON, B.H., 1989. The Evolution of Copper Refinery Slime Processing and Precious Metal Treatment at CCR Division - Noranda Minerals. Precious Metals 1989, IPMI, B. Harris Ed., pp. 403-413.
91. MOTTERAM, G., 2000. Black Range Minerals Syerston Project. A Unique Nickel Laterite. Alta 2000 Nickel/Cobalt Conference.
92. NALDRETT, A.J., 1981. Platinum-group element deposits, Chapter 10. In Platinum-Group Elements: Mineralogy, Geology, Recovery. Edited by L.J. Cabri. Canadian Institute of Mining and Metallurgy, Special Volume 23, p. 197-231.
93. NDLOVU, J., 2001. Pietersburg Smelter Project - A State of the art Furnace Installation Forms the Heart of a New Smelting Complex in the Pietersburg Area. SAIMM Colloquium - Developments in Metallurgical Processing in the Platinum Industry, Rustenburg, November.
94. NEWMAN, L., MAKWANA, M., 1997. "Commissioning of the Stillwater Mining Company base metals refinery" Nickel Cobalt 97, Vol. 1, Hydrometallurgy and Refining of Nickel and Cobalt, Cooper and Mihaylov, Eds. 27th Annual Hydrometallurgy Meeting, CIM, Sudbury, pp. 31-46.
95. NICOL, M.J., 2000. The Monitoring of the Speciation of Iridium in the Separation of Iridium from Rhodium, in Iridium, Ohriner, Lanam, Panfilov, Harada (Ed), pp. 351-359.
96. NORTH AMERICAN PALLADIUM LTD., 2001. Process Plant Fact Sheet.
97. OBERTHUR, T., 2002. Platinum-group element mineralization of the Great Dyke, Zimbabwe. In The Geology, Geochemistry, Mineralogy and Mineral beneficiation of Platinum-Group Elements. Edited by L.J. Cabri. Canadian Institute of Mining, Metallurgy and Petroleum, this volume, p. 367-387.
98. PATRUSHEV, V.V., 1998. Reduction of Platinum Group Metals in Phosphoric Acid Solutions by Formalin. Hydrometallurgy 50. pp 89-101.
99. PECK, D.C., SCOATES, R.E.J., THEYER, P., DESHARNAIS, G, and HULBERT, L.J., 2002. Stratiform and contact-type PGE-Cu-Ni mineralization in the Fox River Sill and the Bird River Belt, Manitoba. In The Geology, Geochemistry, Mineralogy and Mineral Beneficiation of Platinum-Group Elements. Edited by L.J. Cabri. Canadian Institute of Mining, Metallurgy and Petroleum volume, p. 367-387.
100. PETRUKHIN, O.M., BORSHCH, N.A., ZOLOTOV, YU.A., 1980. Extraction of the Platinum Metals with 2-Octylaminopyridine and some Selectivity Problems of Metal Extraction. ISEC 80, Liege (Belgium).
101. REAVILL, L.R.P., CHARLESWORTH, P., 1990 The Application of Solvent Extraction to Platinum Group Metals Refining. ISEC 90, Liege (Belgium).
102. RIMMER, B. F., 1989. Refining Platinum Group Metals by Solvent Extraction. Precious Metals 1989, IPMI, B. Harris Ed., pp 217-226.
103. ROBINSON, I, 1995. Impala Upgrades at Springs. MBM, June. pp 40-41.
104. ROSATO, L., SHINK, D. Recovery of Palladium from Moebius Cell Electrolyte. Precious Metals 1989, IPMI, B. Harris Ed., p227.
105. RUCKMAN, J.H., 1989. SuperLig Technology for Concentration, Separation, and Purification of Precious Metals. Precious metals 1989, IPMI, B. Harris Ed, pp. 381-389.
106. RULE, C., 2001. Waterval Smelter - Upgrade of Technology to Maximise Metallurgical Efficiency and Adjust to Changes in Feed Specification - Study of Options. SAIMM Colloquium - Developments in Metallurgical Processing in the Platinum Industry, Rustenburg, November.
107. SCHOUWSTRA, R.P., 2000 The slow-cooling process: A mineralogical perspective, CIM Bulletin No. 1036, Jan, pp 168-171.
108. SHAFIQUI ALAM, M., INOUE, K., 1997. Extraction of Rhodium from other Platinum Group Metals with Kelex 100 from Chloride Media Containing Tin. Hydrometallurgy, 46, pp. 373-382.
109. SHESTAKOVA, R.D., NAFTAL, M.N., PETROV, A.F., KOZHANOV, A.L., 2000. Characteristic Features of the Technology of High Copper Converter Matte Leaching Developed for Mining and Metallurgical Company Noril'sk Nickel. Alta 2000 Round Table, Perth.
110. SNODGRASS, R.A., HAY, M.P., DU PREEZ, P.J., 1994. Process Development and Design of the Northam Merensky Concentrator; XVth CMMI Congress SAIMM Vol. 2 pp. 341-357.
111. SOBRAL, L.G.S., GRANATO, M., 1992. Palladium: Extraction and Refining. Minerals Engineering, Vol. 5, No. 1, pp. 17-25.
112. STEENKAMP, M., DUNN, G.M., 1999. Operations of and Improvements to the Lonrho Platinum Base Metal Refinery. EPD Congress 1999, Mishra (Ed), TMS, pp. 365-378.
113. STENSHOLT, E.O., ZACHARIASEN, H., LUND, J.H., 1986. The Falconbridge Chlorine Leach Process. CIM, 25th Annual Conference of Metallurgists. pp. 442-463.
114. STENSHOLT, E.O., ZACHARIASEN, H., LUND, J.H., THORNHILL, P.G., 1988. Recent Improvements in the Falconbridge Nickel Refinery. in Extractive Metallurgy of Nickel and Cobalt, Tyroler, Landolt (Ed), TMS, pp. 403-412.
115. STENSHOLT, E.O., DOTTERUD, O.M., HENRIKSEN, E.E., RAMSDAL, P.O., STÅLESEN, F., THUNE, E., 2001. Development and Practice of the Falconbridge Leach Process. CIM Bulletin, Vol 94, No 1051, June, pp. 101-104.
116. STEYN, J.J., KNOPJES, B., GOODALL, C.M., 2001. Milling and Flotation Testwork on Lonmin Platinum's Pilot Plant. SAIMM Colloquium - Developments in Metallurgical Processing in the Platinum Industry, Rustenburg, November.
117. TER-OGANESYANTS, A.K.,

- ANISIMOVA, N.N., GRABCHAK, E.F., GLAZKOV, V.B., BARYSHEV, A.A., KAMENSKY, V.S., 2000. Process of Treatment of Copper-Nickel Electrolytic Slimes. Alta 2000 Round Table, Perth.
118. TIMOFEYEV, N.I., ERMAKOV, A.V., BOGDANOV, V.I., KUZMENKO, G.F., GORBATOVA, I.D., 2000. Recovery and High Refinement of Iridium in Iridium. Ohriner, Lanam, Panfilov, Harada Ed., TMS, pp 339-350.
119. TURK, D.J. 2001. Stillwater Mining Company Nye Concentrator Operation; SME Annual Meeting.
120. TYROLER, P.M., SANMIYA, T.S., HODKIN, E.W., 1988. Hydrometallurgical Processing of Inco's Pressure Carbonyl Residue. Extractive Metallurgy of Nickel and Cobalt, Tyroler, Landolt (Ed), TMS, pp 391-401.
121. USGS Minerals Information, 2001. Platinum Group Metals Statistics and Information, minerals.usgs.gov.
122. VALTUKH, K.K., KRIVENKO, A.P. and RAVKIN, J.C., 1999. Information Theory on the Costs and the System Economic Estimations of Mineral Resources. Novosibirsk, Siberian, Branch of the Russian Academy of Sciences, 598 p. (in Russian)
123. VAN TONDER, D, CILLIERS, P.J., IZATT, S.R., BRUENING, R.L., 2001. Molecular Recognition Technology in the Platinum Industry. SAIMM Colloquium - Developments in Metallurgical Processing in the Platinum Industry, Rustenburg, November.
124. WAGNER, P. A., 1973. The Platinum Deposits and Mines of South Africa. C. Struik (Pty) Ltd., Cape Town.
125. WANBLAD, D., 2001. ACP Project - Implementation of a New Converting Technology to Create a World Class Environmental Compliant Smelting Complex. SAIMM Colloquium - Developments in Metallurgical Processing in the Platinum Industry, Rustenburg, November.
126. WARSHAWSKY, A., 1983. Integrated Ion Exchange and Liquid-Liquid Extraction Process for the Separation of Platinum Group Metals (PGM). Hydrometallurgy: Research, Development and Plant Practice. Osseo-Asare, Miller (Ed), TMS/AIME, pp 517-527.
127. WASMUND, B, FRANCKI, R., 2001. High Productivity Intense Smelting Developments. SAIMM Colloquium - Developments in Metallurgical Processing in the Platinum Industry, Rustenburg, November.
128. WATKINSON, D.H., LAVIGNE, M. and FOX, P, 200. Platinum-group element deposits in mafic-rock complexes: Examples of magmatic-hydrothermal Cu and Pd-rich deposits in gabbroic rocks from North America. In The Geology, geochemistry, Mineralogy and Mineral Beneficiation of Platinum-Group Elements. Edited by L.J. Cabri. Canadian Institute of Mining, Metallurgy and Petroleum, this volume, p. 299-319.
129. WEISER, T.W., 2002. Platinum-group minerals (PGM) in placer deposits. In The Geology, Geochemistry, Mineralogy and Mineral Beneficiation of Platinum-Group Elements. Edited by L.J. Cabri. Canadian Institute of Mining, Metallurgy and Petroleum, this volume, p. 721-756.
130. WISEMAN, L.G., BALE, R.A., CHAPMAN, E.T., MARTIN, B., 1988. Inco's Copper Cliff Nickel Refinery. Extractive Metallurgy of Nickel and Cobalt, Tyroler, Landolt (Ed), TMS, pp. 373-390.
131. YAN, G.L., ALSTAD, J., 1994. Solvent Extraction of Rhodium with Kelex 100. Hydrometallurgy 94, IMM/SCI Chapman and Hall, pp 701-707.
132. ZHOU, M-F, YANG, Z-X., SONG, X-Y., KEAYS, R.R. and LESHAR, C.M., 2002. Magmatic Ni-Cu (PGE) sulphide deposits in China. In The Geology, Geochemistry, Mineralogy and Mineral Beneficiation of Platinum-Group Elements. Edited by L.J. Cabri. Canadian Institute of Mining, Metallurgy and Petroleum, this volume, p. 619-636.
133. ZIENTEK, M.L., COOPER, R.W., CORSON, S.R. and CERACITY, E.P., 2002. Platinum-group element mineralization in the Stillwater Complex, Montana. In The Geology, Geochemistry, Mineralogy and Mineral Beneficiation of Platinum-Group Elements. Edited by L.J. Cabri. Canadian Institute of Mining, Metallurgy and Petroleum, this volume, p. 459-481.

## APPENDICES

Appendix 1: Pt, Pd and Rh Supply Statistics for the year 2000 (J. Matthey, 2001)

ORIGIN	Pt		Pd		Rh	
	000's oz.	% Total	000's oz.	% Total	000's oz.	% Total
South Africa	3,920	72.5	1,960	24.7	434	58.8
Russia	1,100	20.3	5,200	65.7	280	38.0
North America	285	5.2	665	8.4	20	2.7
Others	105	2.0	95	1.2	3	0.4
Total	5,410	100	7,920	100	737	100
Major PGE Mining Companies						
<ul style="list-style-type: none"> <li>• Anglo Platinum (Amplats) - South Africa</li> <li>• Norilsk Nickel - Russia (Primary and Secondary PGE producer)</li> <li>• Impala Platinum (Implats) - South Africa</li> <li>• Lonmin Platinum (Lonplats) - South Africa</li> </ul>						
Medium and Smaller-size PGE Mining Companies						
<ul style="list-style-type: none"> <li>• North American Palladium Ltd. - Canada</li> <li>• Stillwater Mining Co. - USA</li> <li>• Aquarium Platinum (Kroondal) - South Africa</li> <li>• Northam Platinum (Gold Fields of South Africa) - South Africa</li> <li>• Southern Era (Messina) - South Africa</li> <li>• Koryakgeoldobycha - Russia</li> <li>• Mimosa - Zimbabwe</li> </ul>						
Major Secondary Producers						
<ul style="list-style-type: none"> <li>• Falconbridge - Canada</li> <li>• Inco - Canada</li> </ul>						

Appendix 2: PGM Mentioned in this Text

MINERAL	IDEAL FORMULA	GENERAL FORMULA
Braggite	(Pt, Pd)S (Pd, Pt)S	(Pt, Pd, Ni)S
Cooperite	PtS	(Pt, Pd, Ni)S
Kotulskite	PdTe	Pd(Te, Sb, Bi)
Laurite	RuS <sub>2</sub>	(Ru, Os, Ir)S <sub>2</sub>
Sperrylite	PtAs <sub>2</sub>	(Pt, Rh)(As, Sb, S) <sub>2</sub>
Moncheite	PtTe <sub>2</sub>	(Pt, Pd)(Te, Bi) <sub>2</sub>
Vysotskite	PdS	(Pd, Ni, Pt)S
Geversite	PtSb <sub>2</sub>	Pt(Sb, As, Bi) <sub>2</sub>

Appendix 3: Equipment Specifications

Some Equipment specifications for the Northam Flowsheet

SAG Mill Diameter: 8.5 m (inside shell)  
 SAG Mill Length: 3.05 m (EGL)  
 SAG Installed Power: 4.4 MW (variable speed)  
 Ball Mill Diameter: 5.5 m (inside shell)  
 Ball Mill Length: 6.7 m (EGL)  
 Ball Mill Installed Power: 4.4 MW (variable speed)  
 Rougher Flotation Cells: 6 x 38 m<sup>3</sup> Outokumpu cells  
 Scavenger Flotation Cells: 6 x 38 m<sup>3</sup> Outokumpu cells  
 Cleaner Columns: 3 x 2.44 m diameter by 122.5 meter high

Some Equipment specifications for the Stillwater Flowsheet

SAG Mill Diameter: 1.83 m  
 SAG Mill Length: 5.5 m  
 SAG Installed Power: 800 Hp  
 Ball Mill Diameter: 4.0 m (70% critical speed)  
 Ball Mill Length: 6.1 m  
 Flash Flotation Cell: SK240  
 Rougher Flotation Cells: 4 Parallel banks of tank type cells

Tertiary Grinding: 1250 Hp Verti mill (target grind size 100 µm)  
 Middling/Scav. Flotation: 4 Parallel banks of 5 cells each, total of 170 m<sup>3</sup> capacity  
 First Cleaner: 1 x 10 m<sup>3</sup> cleaner, 2 x 10 m<sup>3</sup> cleaner scavs. (tank type)  
 Second Cleaner: 2 x 5 m<sup>3</sup> (tank type)  
 Third Cleaner: 2 x 0.9 m x 9.1 m Columns  
 Cleaner Re grind Mill: 1.5 m x 2.4 m Ball Mill

Some Equipment specifications for the Lac des Iles Flowsheet

SAG Mill Diameter: 30 ft  
 SAG Mill Length: 14 ft  
 SAG Installed Power: 8, 500 HP  
 Ball Mill Diameter: 20 ft  
 Ball Mill Length: 34 ft  
 Rougher Flotation Cells: 2 Parallel banks of 50 m<sup>3</sup> tank type cells.  
 Scavenger Flotation: 2 Parallel banks of 7 cells each. 130 m<sup>3</sup> capacity per cell  
 First Cleaner: 9 x 30 m<sup>3</sup> (tank type)  
 Second Cleaner: 8 x 5 m<sup>3</sup>  
 Third Cleaner: 2 x 4 ft x 36 ft Columns  
 Rougher Re grind Mill: 200 HP Verti mill  
 Scavenger Re grind Mill: 3 x 1,250 hp Verti mills

Appendix 4: Simplified Flowsheet of Stillwater Base Metals Refinery

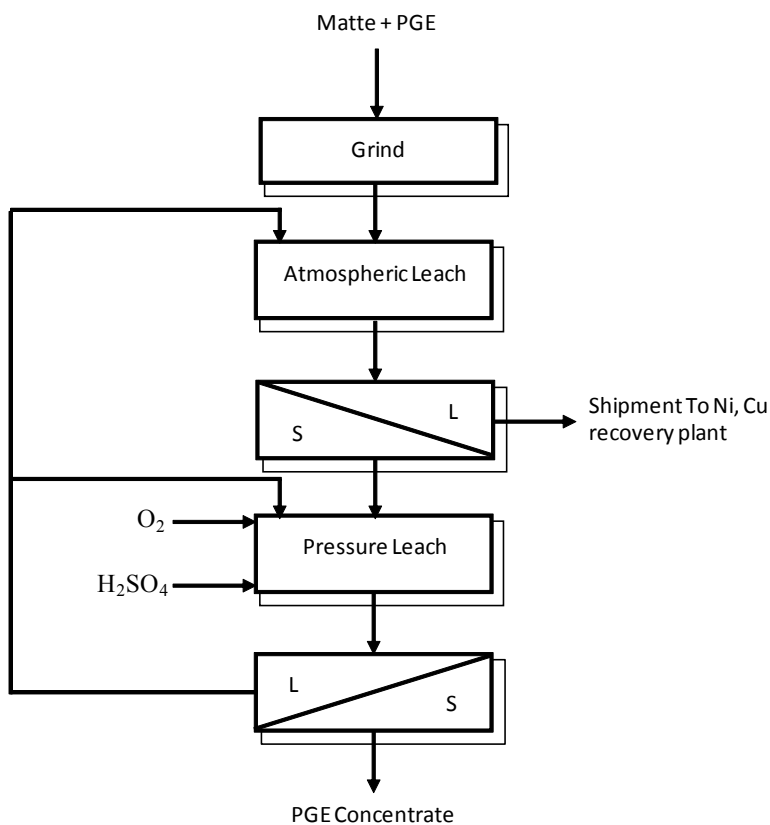



Appendix 5: CCR Anode Slimes Treatment Plant in 1988

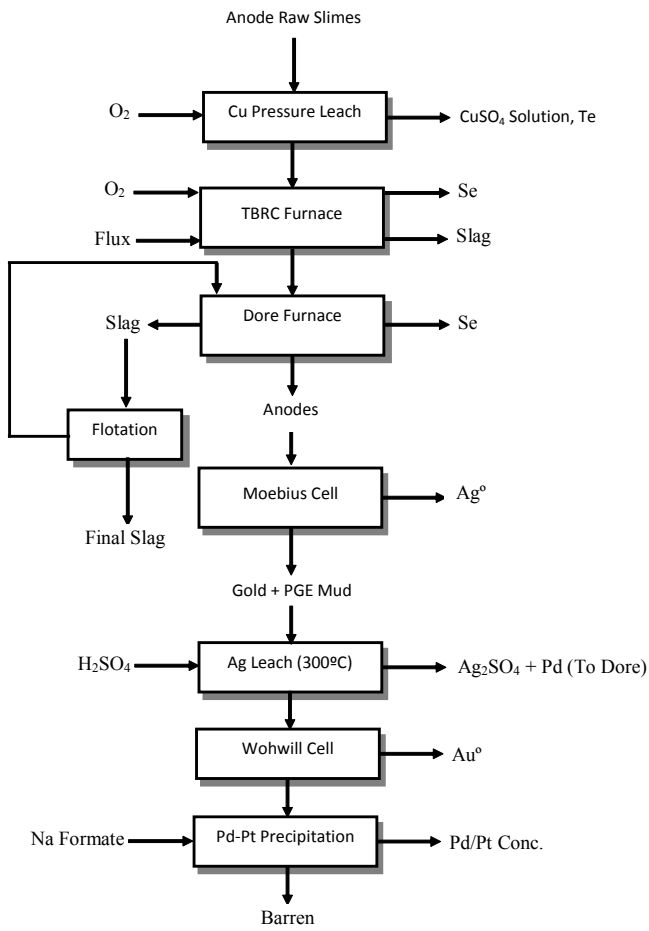

Appendix 6: Precious Metals Refining Process Used at Outokumpu Pori Refinery

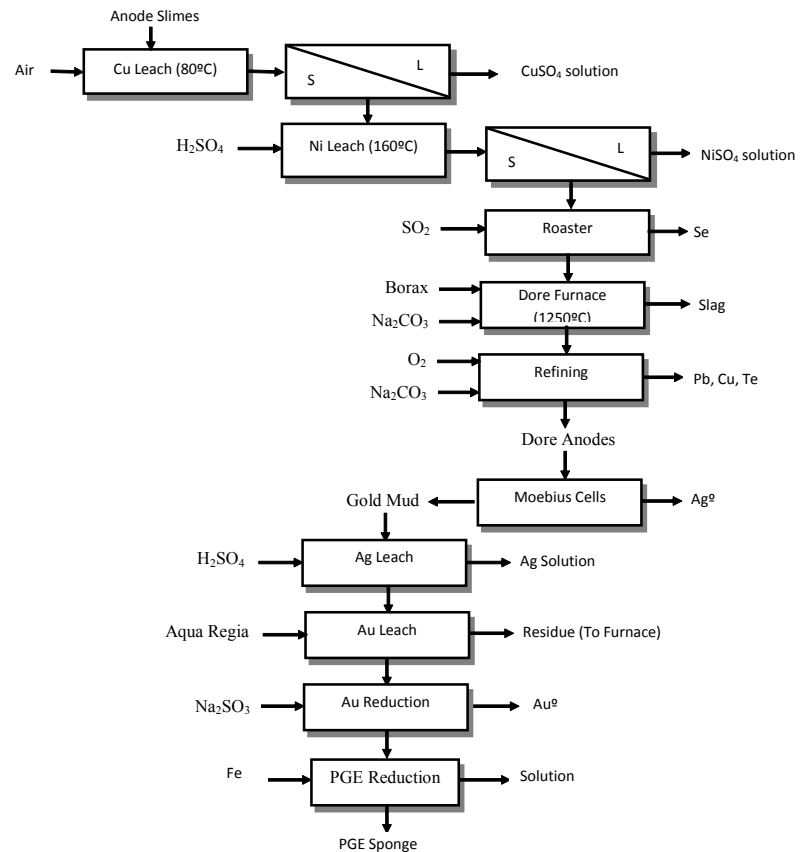

Appendix 7: Fluoride Recovery of Iridium

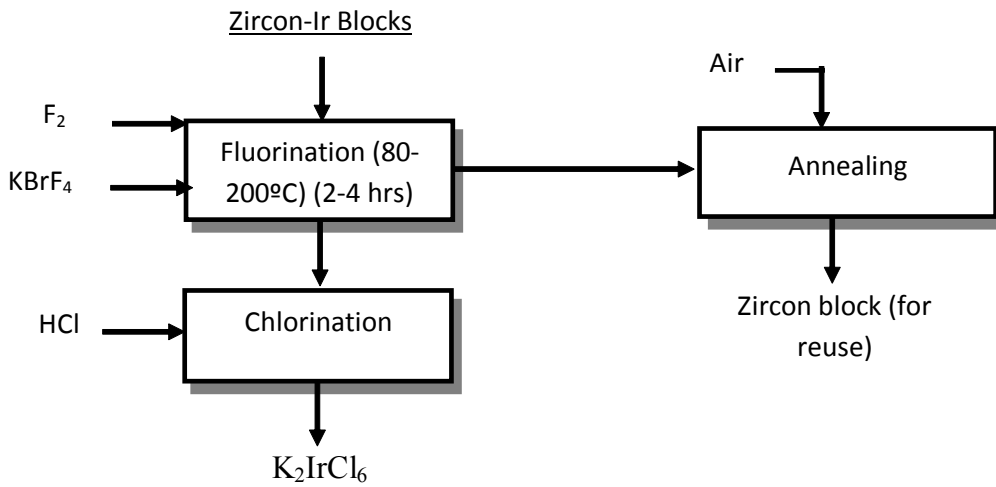

Appendix 8: Electrochemical Refining of Iridium Concentrates

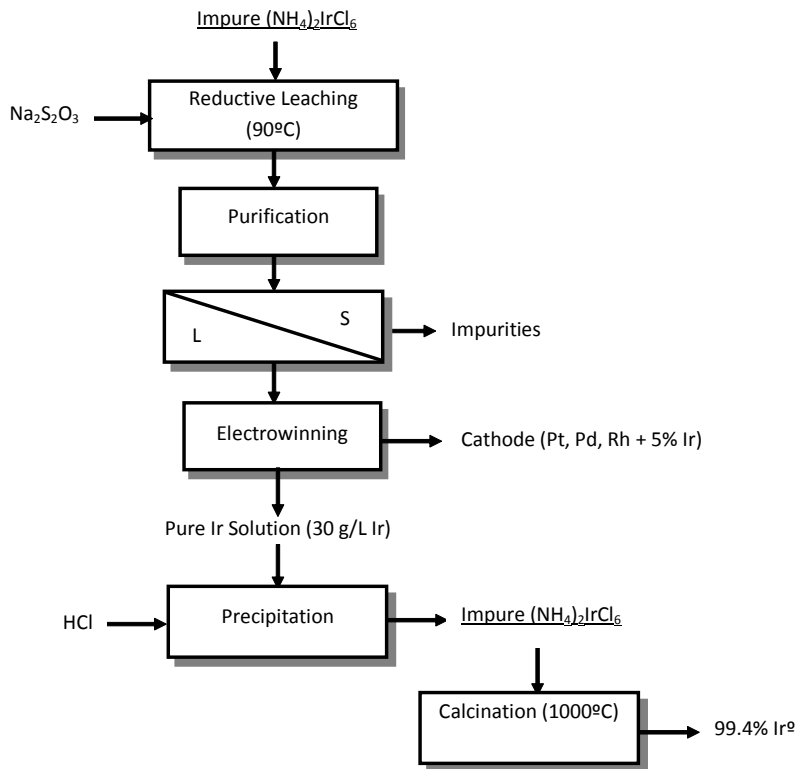

Appendix 9: Abbreviations used in the review

- DBC - Dibutyl/carbitol
- DOS - Di-n-octyl sulfide
- TBP - Tributyl Phosphate
- MRR - Matthey Rustenburg Refinery
- MIBK - Methyl Isobutyl Ketone

---

## CONTACT INFORMATION

Email us at [minerals@sgs.com](mailto:minerals@sgs.com)

[WWW.SGS.COM/MINERALS](http://WWW.SGS.COM/MINERALS)

© 2011 SGS. All rights reserved. The information contained herein is provided "as is" and SGS does not warrant that it will be error-free or will meet any particular criteria of performance or quality. Do not quote or refer any information herein without SGS' prior written consent. Any unauthorized alteration, forgery or falsification of the content or appearance of this document is unlawful and offenders may be prosecuted to the fullest extent of the law.